

Łączenie prostych i okręgów łukiem o danym promieniu

C11

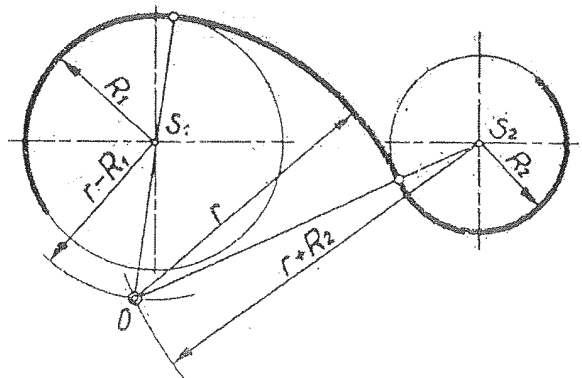

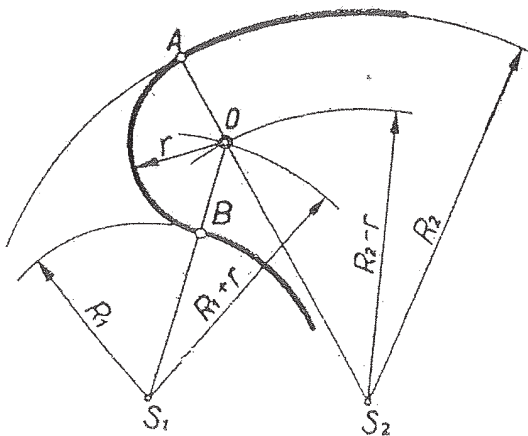
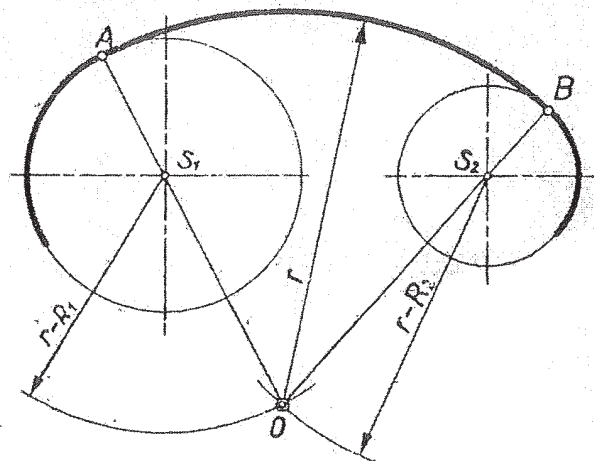
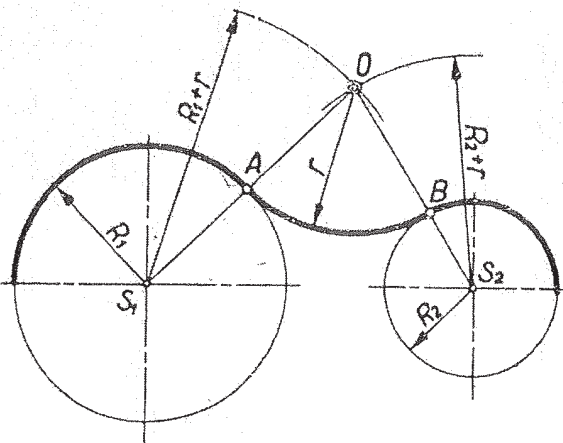
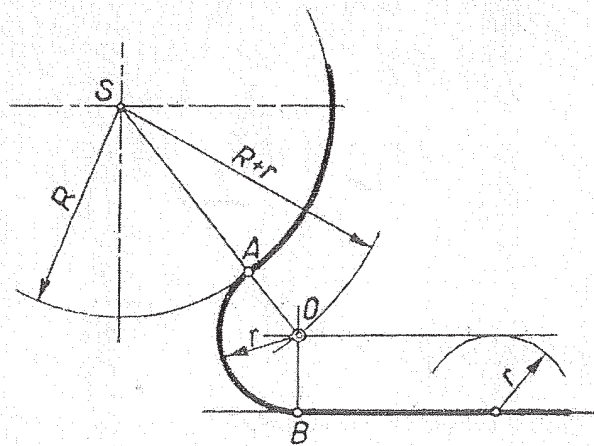
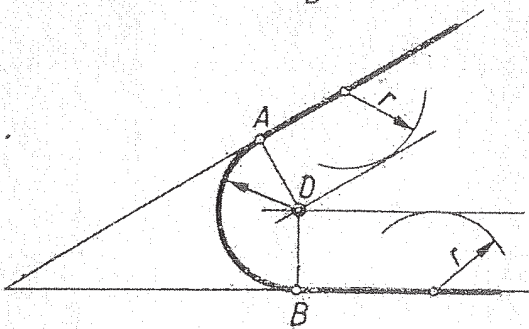
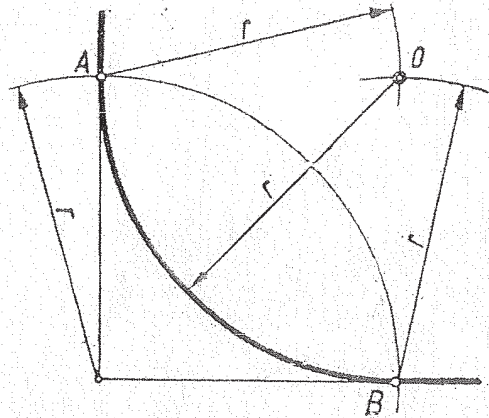
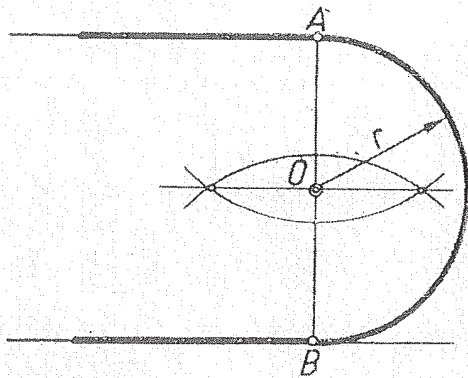
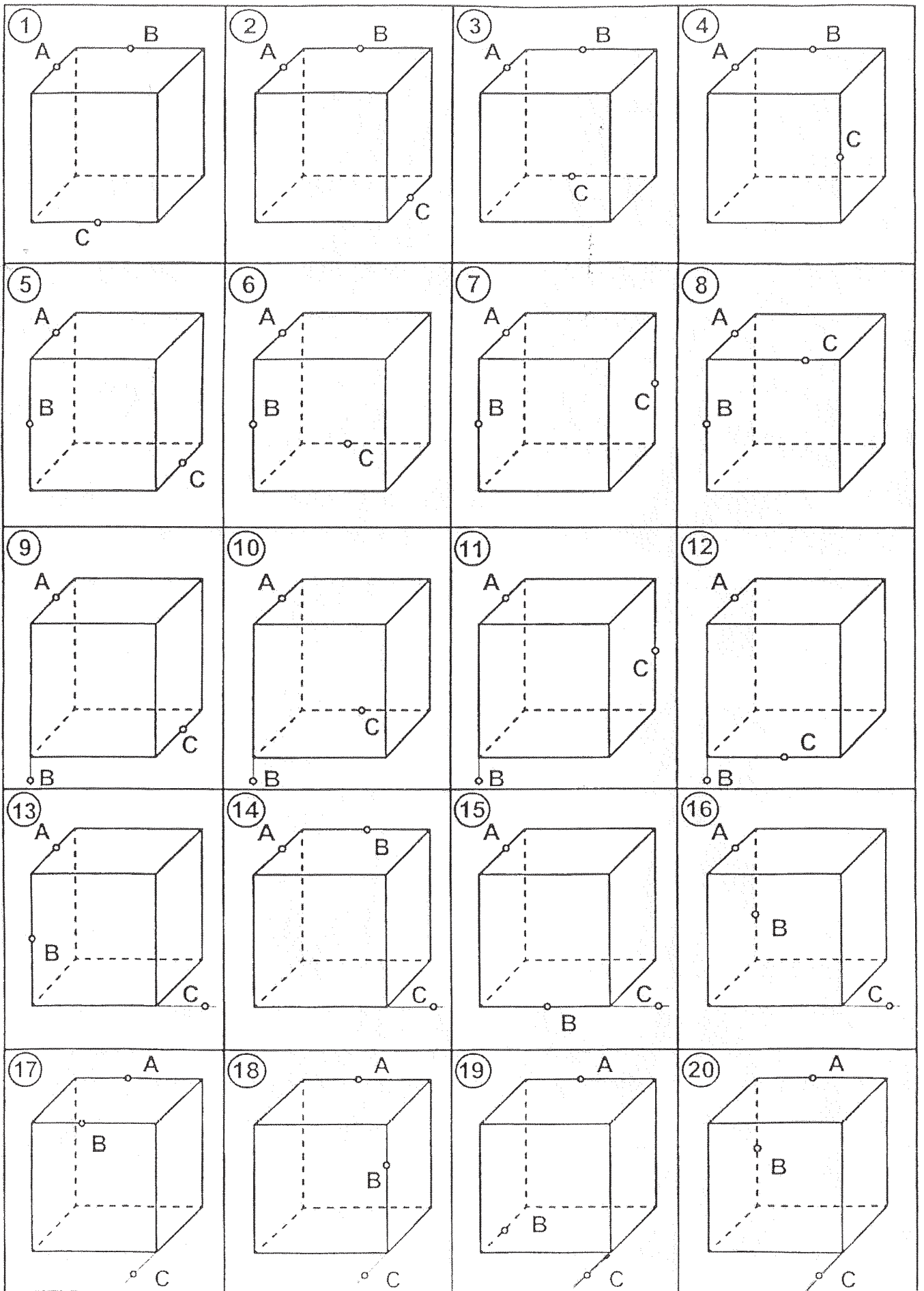

1.5. Zadania do ćwiczeń

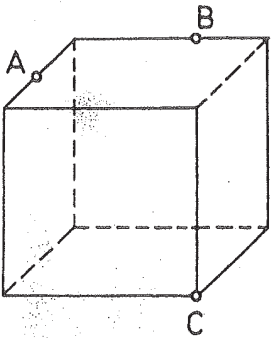
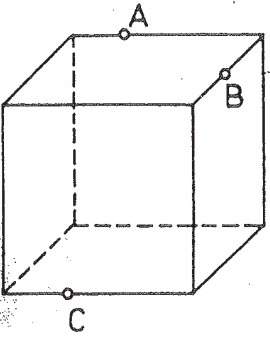
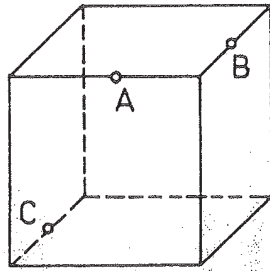
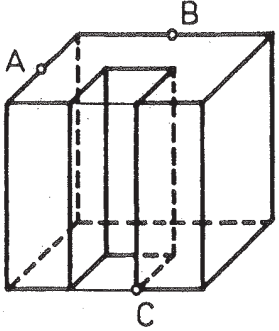
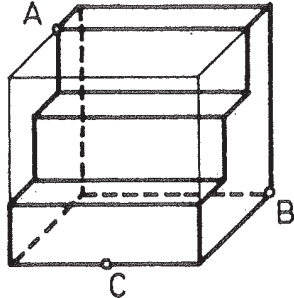
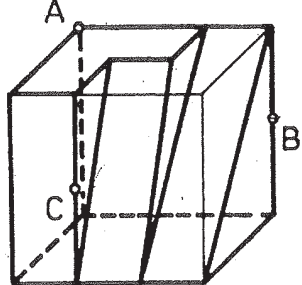
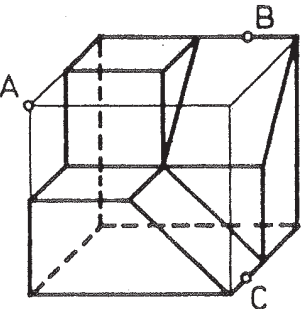
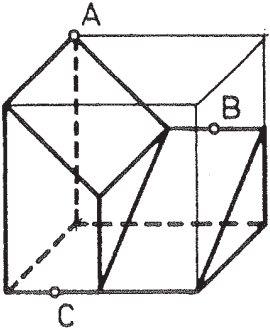
<p>① $\alpha = (A, B, C)$</p> 	<p>②</p> 	<p>③</p> 
<p>④</p> 	<p>⑤</p> 	<p>⑥</p> 
<p>⑦</p> 	<p>⑧</p> 	<p>⑨</p> 