

INHOUSE SYSTEM

RADOPRESS

**DISTRIBUTION OF DRINKING AND HOT
WATER, CENTRAL AND FLOOR HEATING**

PIPELIFE 

RADO PRESS

1. INTRODUCTION

Pipelife RADOPRESS - Hot and Cold system useful in all distribution areas:

- Sanitary - hot and cold water
- central heating
- floor heating

Main advantages of the Pipelife RADOPRESS system

- one system for all H&C applications - sanitary, under floor heating and radiator connection
- quick and economic installation
- permanently leak-proof connection
- fail safe installation tools
- high safety level of performance
- flexible and shape-stable pipes
- efficient joint control using inspection windows
- no corrosion and incrustation
- no oxygen diffusion
- high chemical resistance
- low dilatation of the central heating pipes
- wide fitting range
- highly experienced team

Pipelife insists on highest quality standards in its own production as well as from all suppliers of complementary products.

The Pipelife Radopress system consists of multilayer pipes, brass and PPSU fittings as well as the accessories and professional engineering service.

RADOPRESS pipes

More types of pipes from our system RADOPRESS will facilitate your right choice of the installation

Structure of the RADOPRESS "M" type pipe

- inner PE-X or PE-RT layer
- adhesive layer
- longitudinally-welded aluminum pipe
(The minimum aluminum layer thickness is 0.2)
- adhesive layer
- outer layer made of PE-X or PE-RT

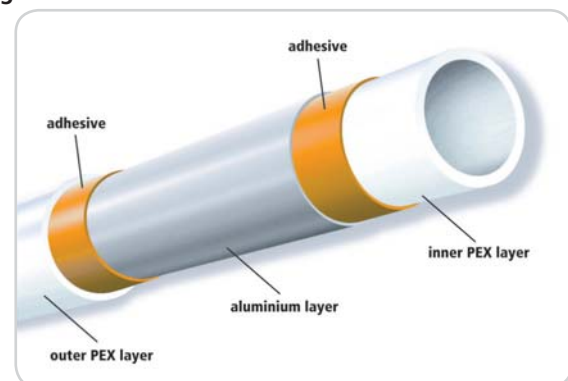

RADOPRESS pipe properties

Multilayered RADOPRESS pipes combine:

- positive properties of the material, i.e. cross-linked polyethylene or PE-RT – corrosion resistance, elasticity, resistance against cracks caused by tension, tear resistance, chemical resistance
- with aluminum properties: high temperature and pressure resistance, shape stability, oxygen tightness, slight thermal longitudinal thermal expansion

RADOPRESS pipe operating conditions

According to the EN ISO 21003, the Radopress is a multilayer „M” type pipe system. It meets the requirements of the class2 (Hot water supply (70°), class 4 (Underfloor heating and low temperature radiators) and class 5 (High temperature radiators) at a design pressure of 10bar.

Classifications of service conditions according to EN ISO 21003-1

| Applica- tion class | Design temperature TD°C | Time b at TD- years | Tmax°C | Time at Tmax- years | Tmal°C | Time at mal-hours | Typical field of application |
|---|--|------------------------|--------|---------------------------|--------|----------------------|--|
| 2 | 70 | 49 | 80 | 1 | 95 | 100 | Hot water supply (70°C) |
| 4 | 20 plus cumulative 40 plus cumulative 60 | 2,5 20 25 | 70 | 2,5 | 100 | 100 | Underfloor heating and low temperature radiators |
| 5 | 20 plus cumulative 60 plus cumulative 80 | 14 25 10 | 90 | 1 | 100 | 100 | High temperature radiators |
| Overall design time period is 50 years. | | | | | | | |
| Note | For values of TD, TMax, Tmal excess of those in the table, this standard does not apply. | | | | | | |

RADOPRESS pipe bending radius

Multilayer RADOPRESS pipes can be easily bent manually in case of smaller diameters ($R_{min} = 5xD$; D - pipe outer diameter) and with a bending spring ($R_{min} = 3.5xD$). In order to ensure the safety bending process on RADOPRESS pipes we should follow the instruction mentioned above, otherwise the pipe can collapse. This way time and fittings are saved.

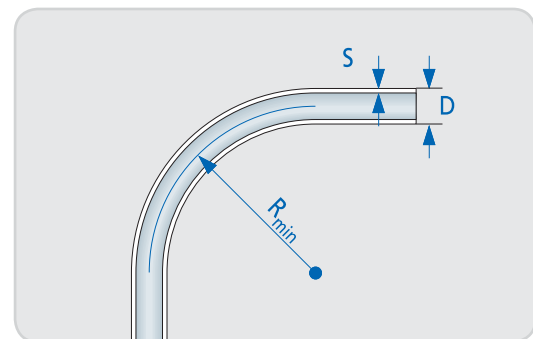

The minimum bending radius "R_{min}" of the pipes

Other features of the RADOPRESS pipes

Multilayer RADOPRESS pipes not only have high abrasion and tear resistance, but they are also entirely unobjectionable from hygienic and toxicological points of view.

As the multilayer pipe furthermore transmits no light, cilia growth is reliably prohibited.

For free installation in buildings, the outer layer is sufficiently stabilized against the UV light. Radopress pipes cannot be exposed to direct sunlight for a longer time period.

RADOPRESS pipe dimensions

Multilayer RADOPRESS pipes are produced in the following dimensions

| | | | |
|---------------|---------------|---------------|---------------|
| D 16 x 2,0 mm | D 20 x 2,0 mm | D 32 x 3,0 mm | D 50 x 4,0 mm |
| D 18 x 2,0 mm | D 26 x 3,0 mm | D 40 x 3,5 mm | D 63 x 4,5 mm |

D16 to D32 pipes are delivered in rolls, D16 to D63 dimensions are supplied in bars, up to the common length of 4 or 5 m.

Pre-insulated RADOPRESS pipes

In addition, pipes in diameter 16 - 32 are also supplied with insulation (red or blue).

DRINKING AND SANITARY HOT WATER, CENTRAL HEATING AND FLOOR HEATING

RADOPRESS pipe advantages

Multilayer Pipelife RADOPRESS pipes are filling the gap between steel and plastic pipes and offer numerous advantages: absolute protection against corrosion, an easy ductility and shape stability, reduced processing costs using cold junction techniques such as pressing and clamp joints. Moreover, directly in the course of the heating connection, many advantages are offered. There is no more time consuming additional painting of connecting places and heating body connection. In addition, the multilayer pipe efficiently decreases transfer of noise and media streaming and pump noise, providing thus noticeable, and gentle warmth.

Longitudinal thermal expansion

Even at high temperatures, Pipelife RADOPRESS pipes only have a slight thermal expansion based on the aluminum layer. The thermal expansion expected in operation can, among others, be read from the diagrams seen below or calculated using the following equation:

$$\Delta l = \alpha \cdot l \cdot \Delta \vartheta$$

α thermal expansion coefficient [mm/mK]
 l pipe length [m]
 $\Delta \vartheta$ temperature difference between assembly and the maximum operating temperature [K]
 Δl longitudinal expansion [mm]

The longitudinal thermal expansion coefficient of the installed Pipelife RADOPRESS pipes is comparable with steel pipes: $\alpha = 0.024 \text{ mm/mK}$.

Diagram - longitudinal thermal expansion of multilayer RADOPRESS pipe

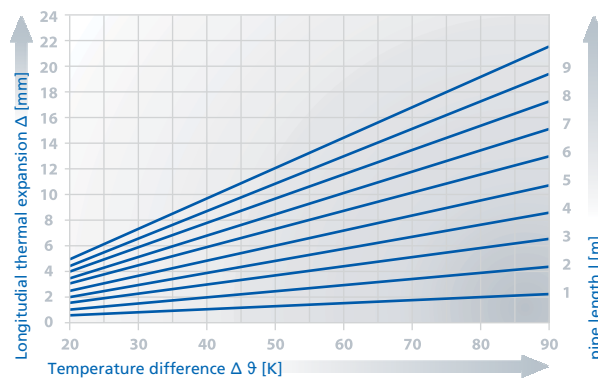

Example applications

$$L_s = k \times \sqrt{d_a \times \Delta L}$$

- k Material dependent constant
- d_a Outside pipe diameter
- F_P Fix point
- S_P Sliding point
- L Pipe length
- ΔL Linear expansion
- L_s Length of expansion leg

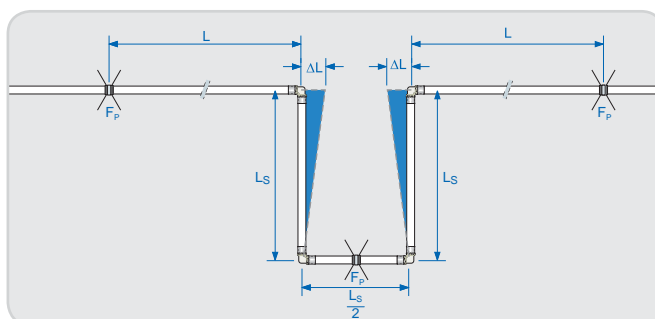
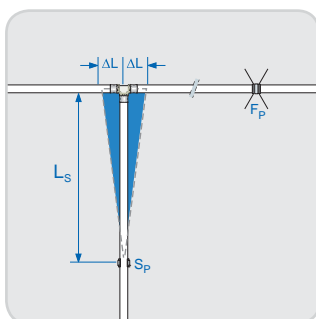
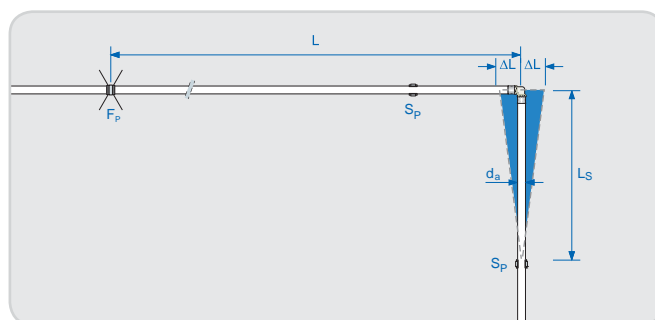

Compensating for changes in length using an expansion leg "L_s" in the riser

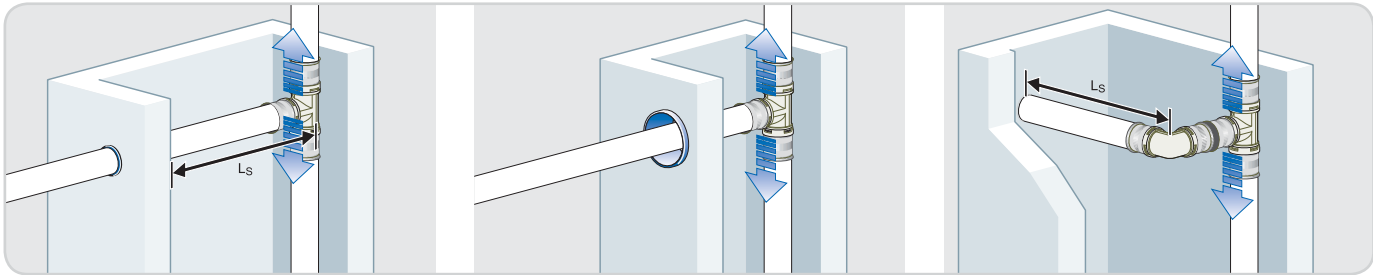

RADOPRESS pipe technical data – type PE-X/Al/PE-X

| Pipe dimension [mm] | 16x2,0 | 18x2,0 | 20x2,0 | 26x3,0 | 32x3,0 | 40x3,5 | 50x4,0 | 63x4,5 |
|--|--------|--------|--------|--------|--------|--------|--------|--------|
| Outer diameter [mm] | 16 | 18 | 20 | 26 | 32 | 40 | 50 | 63 |
| Wall thickness [mm] | 2 | 2 | 2 | 3 | 3 | 3,5 | 4,0 | 4,5 |
| Inner diameter [mm] | 12 | 14 | 16 | 20 | 26 | 33 | 42 | 54 |
| Weight [g/m] | 103 | 140 | 143 | 243 | 393 | 580 | 880 | 1320 |
| Weight with water [g/m] | 216 | 297 | 344 | 557 | 924 | 1436 | 2265 | 3610 |
| Volume [l/m] | 0,113 | 0,157 | 0,201 | 0,314 | 0,531 | 0,855 | 1,385 | 2,29 |
| Thermal conductivity (medium value) [W/mK] | 0,43 | 0,43 | 0,43 | 0,43 | 0,43 | 0,43 | 0,43 | 0,43 |
| Thermal expansion coefficient [mm/mK] | 0,024 | 0,024 | 0,024 | 0,024 | 0,024 | 0,024 | 0,024 | 0,024 |
| Surface roughness (inner pipe) [µm] | 1,5 | 1,5 | 1,5 | 1,5 | 1,5 | 1,5 | 1,5 | 1,5 |
| Oxygen diffusion [mg/l/d] | 0 | 0 | 0 | 0 | 0 | 0 | 0 | 0 |
| Max. operating temperature [°C] | 70 | 70 | 70 | 70 | 70 | 70 | 70 | 70 |
| Short-term max. operating temperature [°C] | 95 | 95 | 95 | 95 | 95 | 95 | 95 | 95 |
| Max. operating pressure (at 70°C) [bar] | 10 | 10 | 10 | 10 | 10 | 10 | 10 | 10 |
| Short-term max. pressure (at 95°C) [bar] | 10 | 10 | 10 | 10 | 10 | 10 | 10 | 10 |
| Bend radius at free bending | 5xD | 5xD | 5xD | 5xD | 5xD | (5xD) | (5xD) | (5xD) |
| Bend radius with bending tools | 3,5xD | 3,5xD | 3,5xD | 3,5xD | 3,5xD | 3,5xD | 3,5xD | 3,5xD |

Fittings

Choose from a wide range the right fitting you need, made of brass or PPSU

The fittings are made of brass or plastic.

In brass fittings production, we are using corrosion-resistant material.

Plastic fittings are made of PPSU (polyphenylsulfone). The material is highly resistant against high temperatures and mechanical loading. The fitting alternative in plastic we offer only for the components not containing a screw part. This aims to increase installation safety in the most sensitive distribution area.



Brass fittings



PPSU fittings



Separated fitting parts

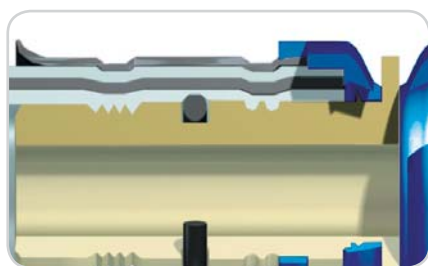

Cross-section of the PPSU fitting

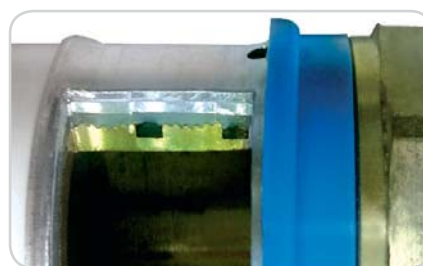

Cross-section of the brass fitting

The fitting is pressed, the maximum pressing force is 10 tons. O-rings provide a safe and tight connection. RADOPRESS fittings are permanently leak-proof. It can be used both under plaster and over it. The exception is represented by transitions with an inner thread - these we recommend to only use over plaster. These transitions cannot be screwed with conical threads, either. Pipe endstopping into the fitting can be, prior to compression, simply checked by a sight glass. RADOPRESS fittings are not sensitive to temperature changes, pressure stroke loading, torsion or tension. The complete fitting production program is available for you in the dimensions D16 to D63. Make sure about our wide fitting assortment in pricelists.

Operating conditions of RADOPRESS fittings

The RADOPRESS fittings as part of the system, fulfill the requirements according to the EN ISO 21003-3.

RADOPRESS fitting benefits:

- well considered, versatile program offer
- suitable heating and sanitary areas
- fast, simple and safe assembly
- visual inspection before and after pressing
- protection against electro-magnetic corrosion
- smart structure of fittings and accessories prevents the most frequent assembling failures (incorrect fitting position in pressing jawbone)



2. RADOPRESS DRINKING AND HOT WATER DISTRIBUTION

The system of sanitary distribution is fast and safe. Especially the high installation speed significantly compensates slightly higher component prices in comparison with purely plastic PP-R solutions or purely steel systems made of zinc-coated steel. However, safety and flexibility of the RADOPRESS system are much higher.

Distribution concept

The RADOPRESS system can be used for the distribution of drinking and hot water, in a common way, using T-pieces, with serial installation using double wall pieces or with a technique making use of a manifold installation.

branch connection

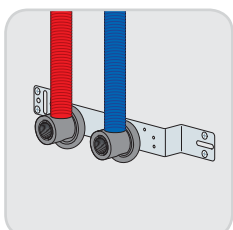
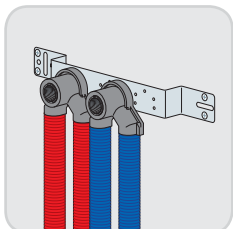
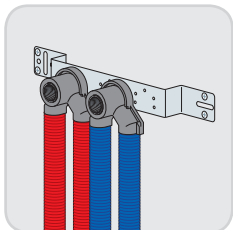
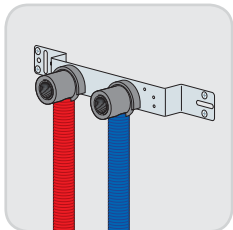

mainline connection

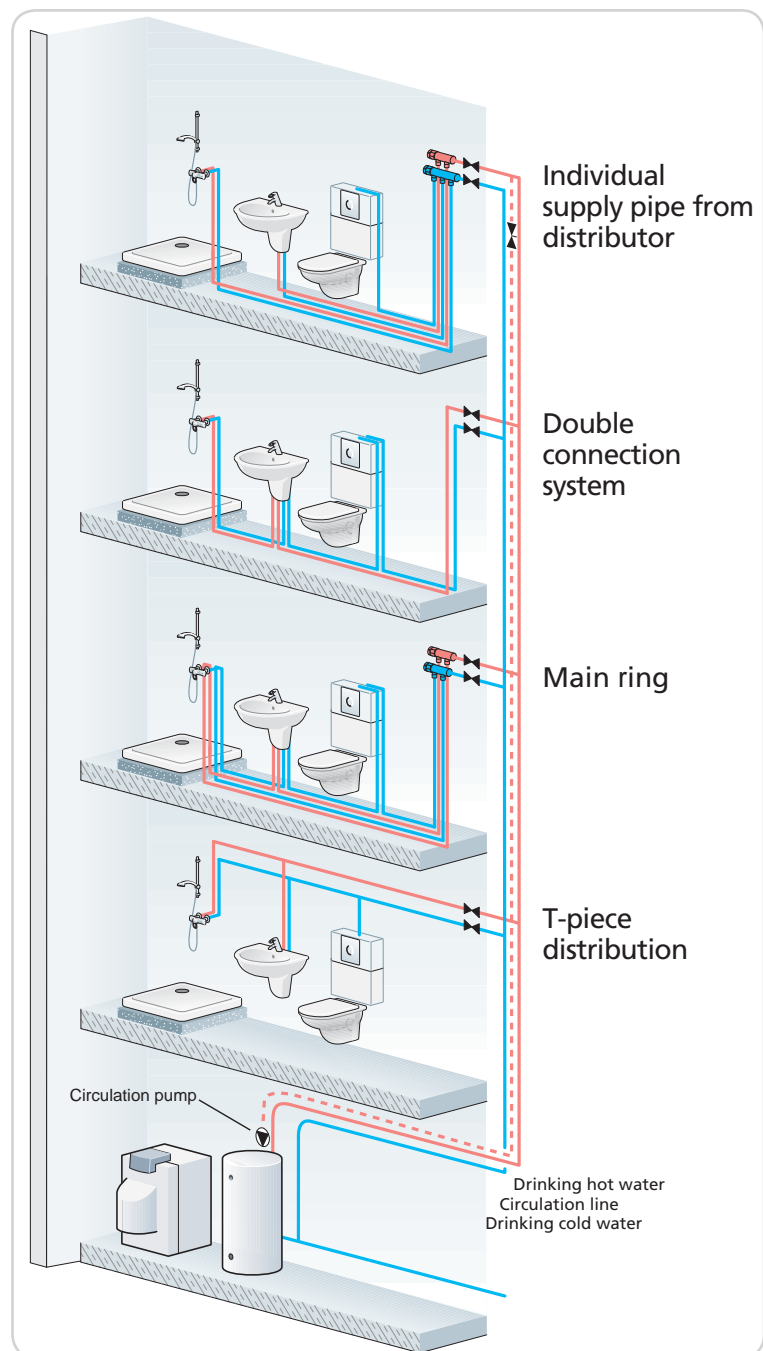
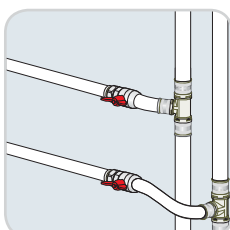
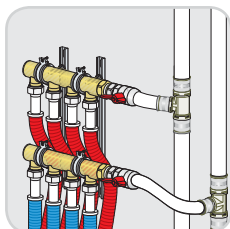
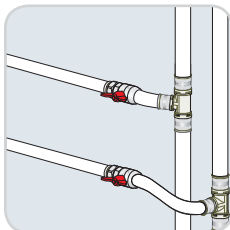
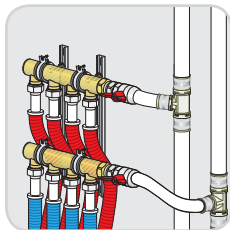

To ensure the required water temperature even at the last point of the system, a so called circulation line is used, that runs parallel with hot water line and equipped with circulation pump. Having the necessary temperature (60°C) in the pipe, unwanted legionella bacteria will not be able to survive.

For compensating dilatation movements and avoiding vapour condensation pre-insulated pipes or insulating tubes could be used. Wallpiece connections are available in both single and double designs.

DRINKING AND SANITARY HOT WATER, CENTRAL HEATING AND FLOOR HEATING

To improve the protection against noise (and prevent condensation), you may complete armature connections with anti-noise protection elements.



Wall piece (short)



Wall piece (long)



Double wall piece



Pre-assembled wall pieces



Anti-noise element



Insulated wall piece

Certification, health protection

The RADOPRESS system is certified by the authorized body of technical requirements on products and in accordance with the actual governmental regulation meeting the technical requirements on building industry products. Drinking water pipes meet the conditions of health protection and conditions for a permanent contact with drinking water, according to the hygienic demands on products coming into direct contact with water and about the water treatment (leak tests). Valid documents are published on www.pipelife.com or can be sent to you by request.

Pipe insulation

- Inner water conduit piping cannot be conducted through spaces where, under normal operation, the temperature falls below 5°C, if the distribution is not treated against the effects of temperature decreasing (by e.g. insulation).
- Cold water piping (conducted freely, placed in slots in installation channels etc.) must be protected against dewing.
- Freely conducted cold water piping in warm or heated surroundings, conducted in parallel to heating distribution or warm and circulation water distribution, must be protected against temperature increasing (by e.g. insulation). Parallel piping of cold drinking water and warm water must be insulated against heat, thus preventing reproducing of undesirable bacteria.
- Hot water piping and circulation piping with forced water circulation must be thermally insulated against heat losses and linear thermal expansion, in agreement with the requirements of valid standards.
- For insulation various materials can be used such as foam, foamed polystyrene, mineral fiberglass or insulations based on foamed PE, PP or PUR.
- Insulation tubes must be mounted with a pre-stress, according to manufacturer's instructions, because natural shrinkage must be expected in longitudinal direction in foamed materials.

Pressure tests

- After finishing the assembly, the inner water conduit must be, still prior to connection to public water conduit or own water source, inspected and subjected to pressure tests. A record is made about the inspection and pressure test, in compliance with appropriate directions.
- The piping tests are to verify its completeness, internal pressure resistance and tightness.
- Before the pressure test, all of the inner water conduit must be rinsed with water and, simultaneously, discharged in the lowest point.
- The pressure test is carried out after the assembly of accessories, furnishings, instruments and devices (cocks on the water supply network, insurance armature, pumps, heaters, etc.).
- Inner water conduit is tested by the pressure amounting to 1.5 of the operating pressure, however, at least, by the pressure of 1.5 MPa.
- After filling with water, the inner water conduit is being stabilized by the operating overpressure for at least 12 hours. After the time, the pressure is increased into the testing overpressure. One hour after reaching the testing overpressure, the pressure cannot decrease by more than 0.02 MPa. At a higher decrease, the pressure test is not appropriate.

3. CENTRAL HEATING DISTRIBUTION

In practice, the range of RADOPRESS products cover all utilization areas in the sphere of heating installation.

The rich production versatility of the RADOPRESS system offers technically and economically satisfying solutions in all cases and for various methods of installation.

Single-pipe system

The simplest way of radiator installation is single pipe system. Because of the serial connection heat distribution is not even between the radiators. Therefore resistance of all elements of the system is cummulated which requires a high pump flow and pressure.

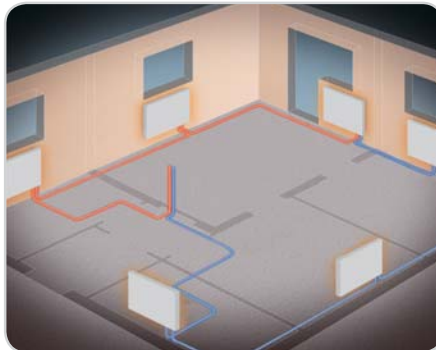

Double-pipe system

Our RADOPRESS system with multilayer pipes is the most suitable for the double-pipe system installation, without a heating circuit central manifold. A wide range of dimensions D16 to D63, as well as our extensive fitting assortment enables fast, safe and trouble-free double-pipe system performance.

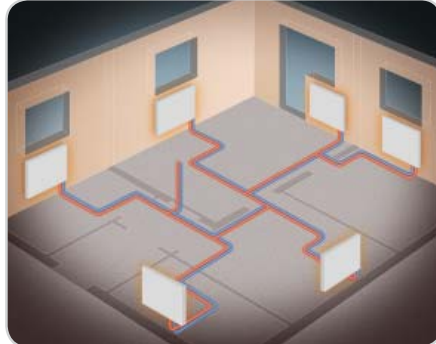

Caution:

Do not perform the connection of heating bodies, manifolds and collectors directly. To retain linear expansion, the pipes should be placed in the distance of approx. 1.5 m from a heating body, in the angle of 90°. This way you will enable the piping system catching the linear expansion.

Manifold system

For heater connection, pipes in D16 are normally used. In heaters with an extremely high output and a high temperature gradient, the connection with a higher pipe diameter may be needed.

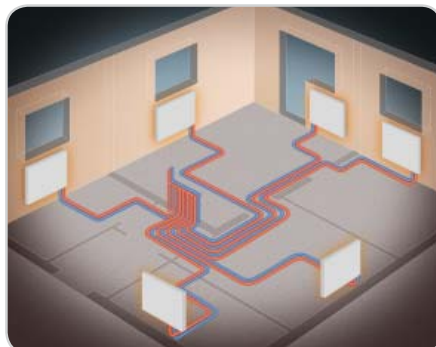

DRINKING AND SANITARY HOT WATER, CENTRAL HEATING AND FLOOR HEATING

Manifolds and collectors are supplied assembled in advance from the factory. Manifold and collector outputs are equipped with a conical screw Eurocones.

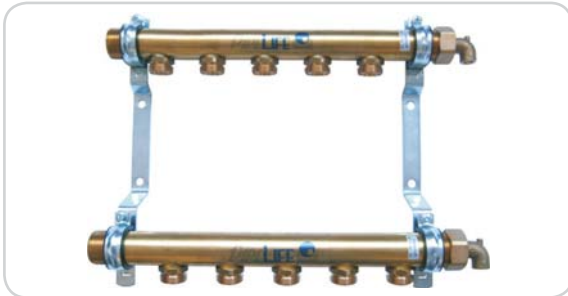

Radiator heating distributor



Eurocones

Radiator connection

A wide range of radiator connections are available in the Radopress system

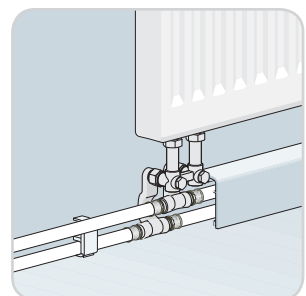
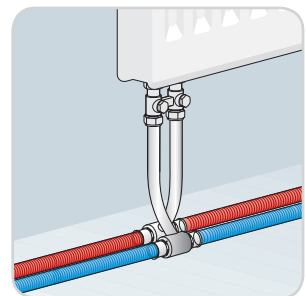
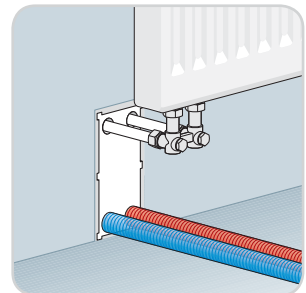
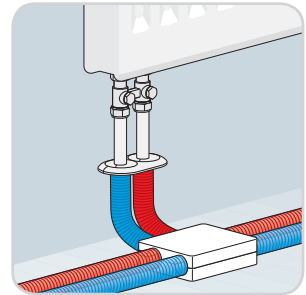
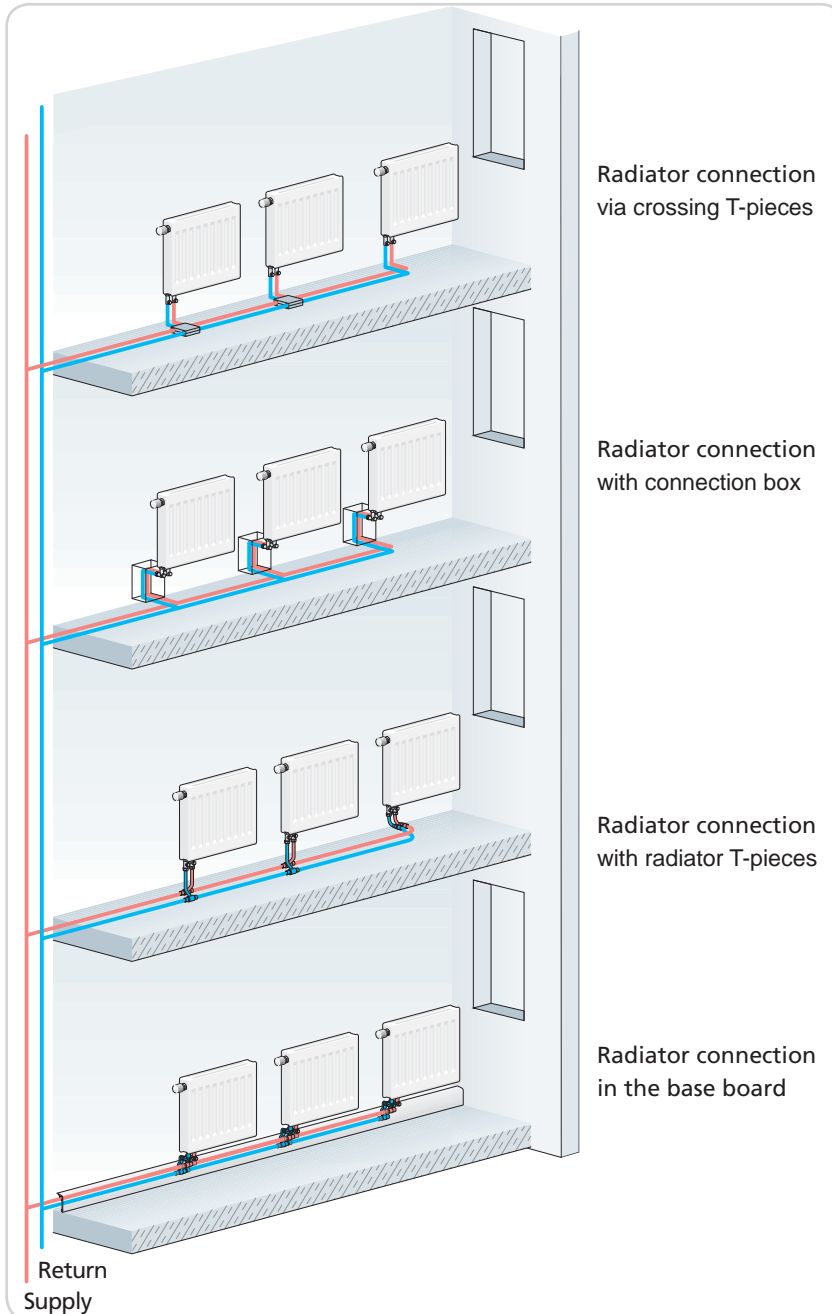

Direct pipe connection (connection with t-pieces or non crossing t-pieces)

The direct pipe connection with a binder screw is considered the simplest and most favorable way of heating body connection. In the system of multilayer PADOPRESS pipes, the pipes are bent mostly with a bending spring in appropriate radius and connected to the heating body. In case of limited height of the upper concrete layer the radiator connection can be done by using non crossing t-pieces.

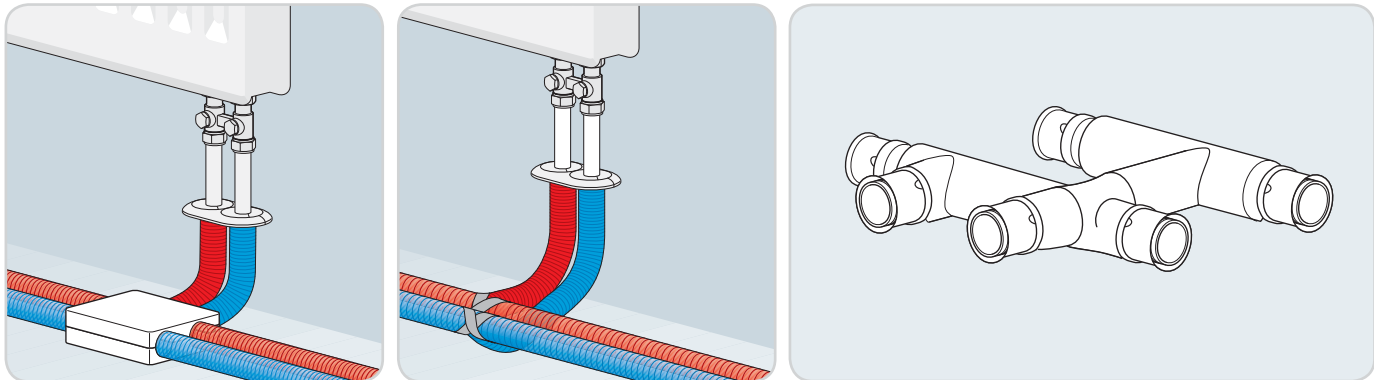

Connecting sets

In case the heating bodies are connected from the floor or wall, you may also use RADOPRESS chromium-plated connecting bends and T-connectors. The multilayer pipe connection is realized as a pressed junction. Use T-connectors for straight pipes, connect the last heater using connecting L-shape bends. The L-bends as well as the T-connectors are produced in lengths of 300 and 1100 mm. This will guaranty a maximum flexibility during the connection to the heating body. Mount the connecting sets in the manner they cannot move on pipe dilatation. Situate dilatation bends on other direct pipe routes in the manner enabling the pipe retaining longitudinal expansion.



Radiator T-piece



Radiator elbow



Radiator connection via radiator elbows



Radiator connection via radiator T-pieces

Connecting box

Due to a premature heater mounting various problems occur on many construction places. Because of plastering and painting works, the heaters must be dismantled and temporarily deposited, which often causes thefts and damages. In valve compact heating bodies, the connecting box of Pipelife RADOPRESS (RP-BOX) heaters will enable you to mount the heaters after finishing the painting works. In the first stage, only the box (RP-BOX) of the wall heater must be settled. We recommend performing piping installation as late as after plastering works that will prevent eventual damaging of the pipes by a building company.

Working with a connecting box

1. Cut the space for the connecting box into the wall.
2. Now fasten the box either using PU foam or a suitable, fast-setting concrete.
3. After plastering remove the protective cover.
4. Finally calibrate freely located pipes, chamfer the edges and connect a heater.
5. After the pressure test, the connecting pipe for the heater is cut according to the construction depth. Then the heating body valve may be installed.



Plinth connection

If the Radopress pipelines are routed in the plinth area, the radiator connection is made using the radiator plinth connection set.

There are two different connection types for the radiator, like the adapter bend without shut-off and a balancing elbow with built in shut-off valve. Both sets include connection screw fitting.

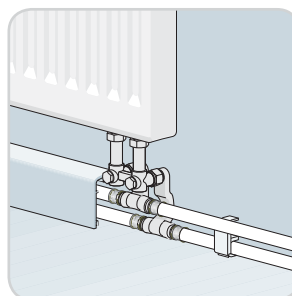
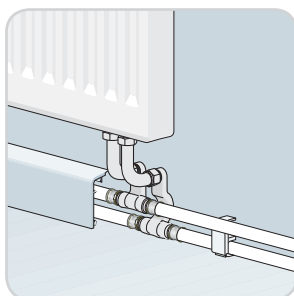

radiator plinth connection



adapter bend without shut-off valve



balancing elbow with built in shut-off valve

Pressure tests

The pressure test is carried out under the testing pressure equal to the highest operating pressure, increased by 0.2 MPA. The test course is identical to that of drinking water distribution.



4. FLOOR HEATING DISTRIBUTION

Floor heating distribution using RADOPRESS system - you will install it easily, quickly and in a good quality

General information about floor heating:

Floor heating benefits:

- better thermal comfort
- high energy efficiency (lower supply water temperature)
- even temperature
- no restrictions on interior heating layout

Floor insulation:

For floors placed above heated spaces we recommend polystyrene with the thickness of 4-5 mm, for locations above non-heated spaces we recommend polystyrene with the thickness of 8-10 cm.

Dilatation joints:

- *perimeter dilatation* is carried out always on the floor perimeter:
 - we solve using dilatation perimeter band
 - *block dilatation* is realized in the following cases:
 - heating block area is higher than 40 m²
 - Ratio of floor sides length / width is higher than 2
 - Heating block length is higher than 8 m - Passes through holes (e.g. doors)
 - we solve this using dilatation bend; between dilatation joints protective pipe must be used.
- Where the pipes come out of the concrete floor (to join to the manifold) also protective pipes must be used.

Heating loop layouts:

- spiral placing - even temperature distribution on the whole heating surface
- serpentine placing - uneven temperature distribution
- spiral placing with border zone - in case of requirement of higher temperature of the floor border part (e.g. at enclosure wall)
- We can also increase the temperature in the border zone (along outer wall) by decreasing the distance between the floor heating pipes.

Concrete plaster floor with plasticator

The layer of concrete plaster floor above the pipe must be at least 5 cm. We recommend using cement topping - cement concentration 300-350 kg/m³, water/concrete ratio 0.45, gravel granularity lower than 8 mm. To improve plasticity and thermally-technical properties of concrete plaster floor, it is recommended to add to the concrete compound a plasticator.

On cementation with the concrete plaster floor, the pipes must be filled with water, under the pressure of 0.3 MPa.

Pressure tests and starting

The pressure test is carried out before the pipe cementing with concrete plaster floor, namely under the pressure of 0.6 MPa for the period of 24 hours. The concrete plaster floor must be let dry up in natural conditions (i.e. 3-4 weeks), then we start with the first heating at the water temperature of 25°C. The temperature shall be kept for 3 days. Then the temperature shall be increased by 5°C per day, as far as to maximum temperature.

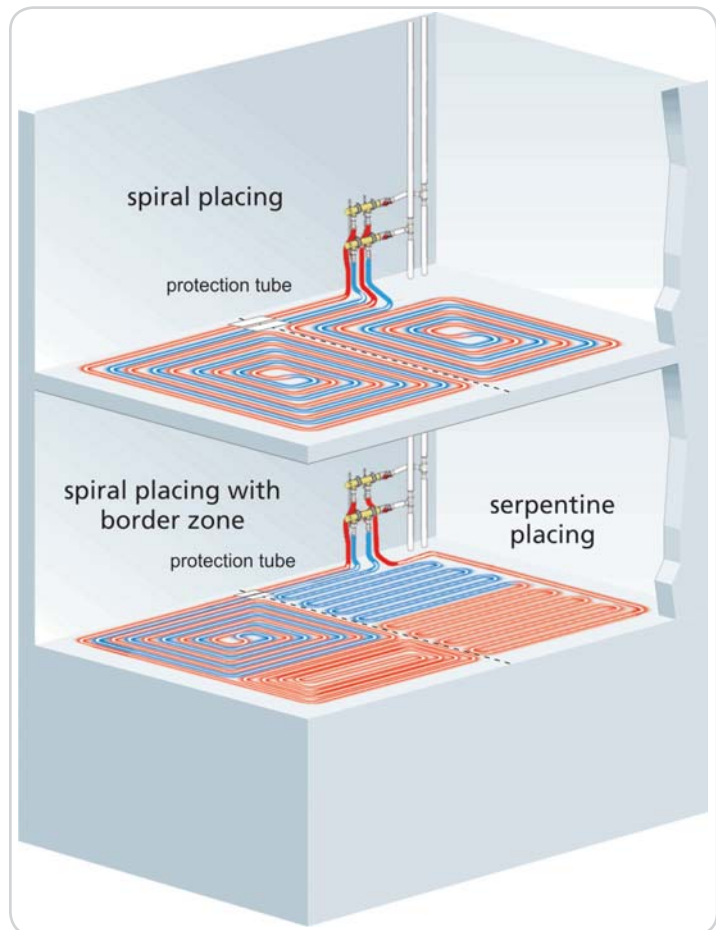
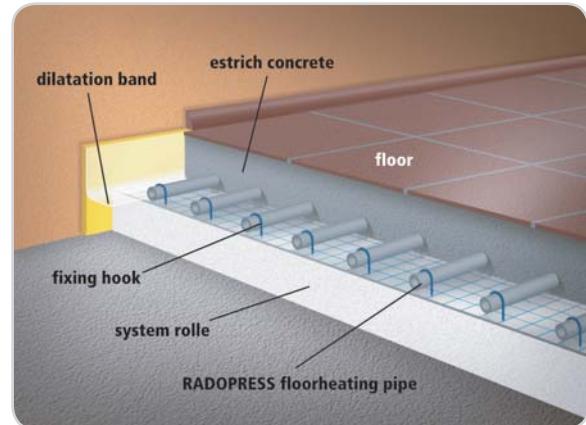

Components of RADOPRESS system for floor heating

RADOPRESS pipes for floor heating

In the Radopress system there are two different types of floor heating pipe.

The „M“ type PEX/AL/PEX and PE-RT/AL/PE-RT pipes are already described. Thanks to the aluminium insert these pipes are flexible and shape-stable which makes them applicable in floor heating systems.

Pipe PE-RT EVOH - the pipe of “P” type - multilayer pipe with EVOH layer (Ethylen-vinyl alcohol plastic). Using the barrier layer made of EVOH material will prevent oxygen diffusion through PE-X pipe wall; oxidation processes in the heating circuit are efficiently suppressed, thus suppressing the corrosion of kettle, boiler or radiators. The EVOH layer is protected against outer damaging by a polyethylene layer.

All of the layers are permanently inter-connected with an adhesive layer. As PE-RT material, the non-cross-linked polyethylene with increased temperature resistance is considered.

One of the main elements of the system is the **RADOPRESS system rolle** (floor heating base panel), which is an aluminum, fiber reinforced, heat-reflecting foil, laminated on a 3 cm thick EPS-T polystyrene insulation. There is a 5 cm scaled reference grid on its surface, which makes path measuring unnecessary. The base panel is sold in a 1x10 m coil, which facilitates the transport and storage. Laying the base panel is also a simple procedure, because due to the self-adhesive edge, no adhesive tape is required to assemble the separate sheets.

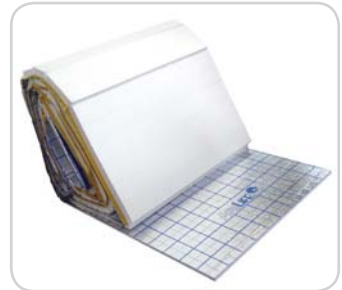

Tools and fixing material

Laying of circuits is facilitated by the fixing technique of the system. Fixing clips for mounting of the floor heating circuits are fixed using a stapling machine. Quantity and spacing of the fixing hooks have to be chosen as needed. Usually pipes only need to be fixed between one half and one meters, but because of the high deflecting force, double fixing must be used before and after the bends. Because of reinforced fabric, pipes will not pull off hooks from insulation.

In case of conventional “steel grid” installation we can offer the Easy Clip system. This consists of a special fixing tool which can be used to push down the clips on the steel grid for safe and durable fixation of the pipes.

System rolle installation



Fixing tool

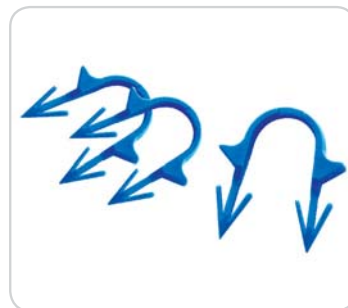

Fixing clips





Distributors and mixing units

Pipelife offers 3 basic types of manifolds for different applications:

- manifolds for drinking water systems (2-6 circuits)
- distributors-manifolders for radiator heating systems (2-10 circuits)
- distributors-manifolders for floor heating systems (2-12 circuits)

The 1" distributor body with $\frac{3}{4}$ " euro cone outlets is made of high quality brass. There is 1" outer thread on one side of it, and an inner one on the other side which makes the mounting easier. To close the end of the manifold body, we have to use inner threaded end caps with flat sealing. The end piece is available to connect $\frac{1}{2}$ " air vent or charging valve.



Manifold for sanitary distributions



Manifold and collector for central heating

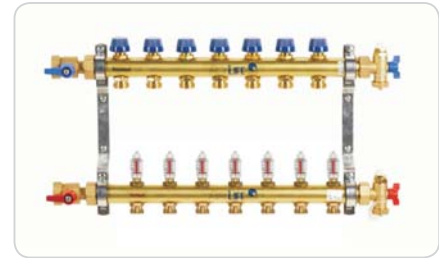

Pre-installed distributor with flow meter

DRINKING AND SANITARY HOT WATER, CENTRAL HEATING AND FLOOR HEATING

The Radopress pre installed floor heating distributors are supplied with preinstalled shut-off valves, valves, flow meters at each circuit, charge-discharge and air-separator valves, main ball valve and sound proof fixing frame. It is packed in a box with mounting parts and labels.

There is a new type available with combined shut-off flow meter valve. Thanks to the male threaded connection on both sides through flat sealing and to the G 3/4" Euro cone connection it is easy to install. The distance between the outlets is 55mm. The fine control valve in the supply controls the flow rate of the heating circuits. Shut off valves for return pipe connection are M30x1,5 threaded. The low depth enables installation in walls with thickness of 90mm. The whole set was tested of function and pressure via differential pressure test procedure.

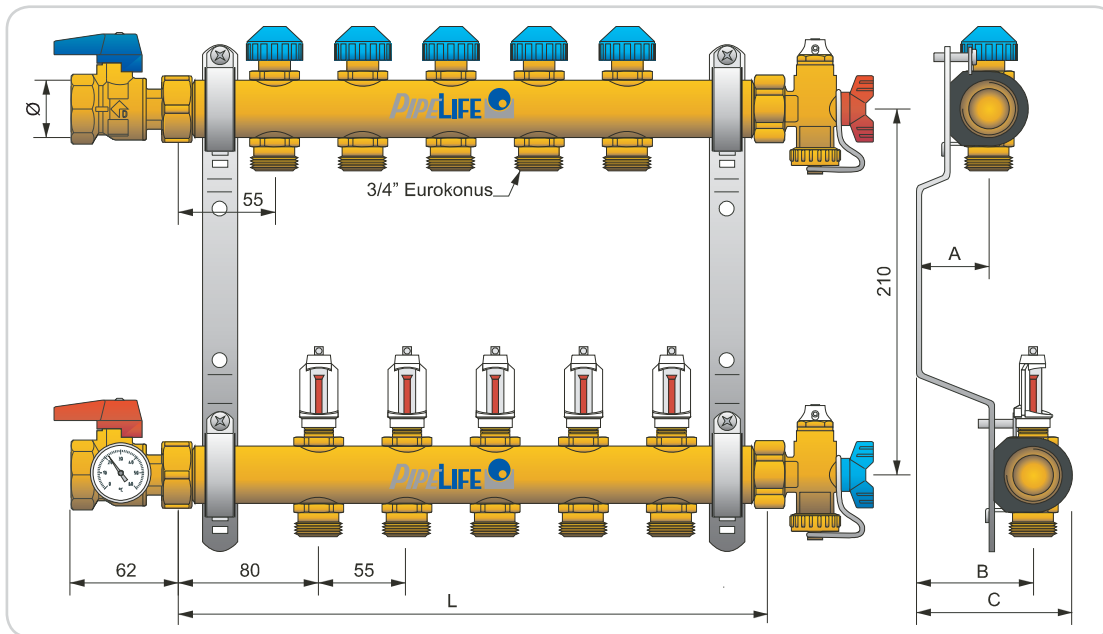

Due to different types the supply pipe could be on the top

| | |
|-----------|------|
| Dimension | 1" |
| A [mm] | 39 |
| A [inch] | 1,54 |
| B [mm] | 64 |
| B [inch] | 2,52 |
| C [mm] | 86 |
| C [inch] | 3,39 |

| | | | | | | | | | | | |
|---------|-----|-----|-----|-----|-----|-----|-----|-----|-----|-----|-----|
| Outlets | 2 | 3 | 4 | 5 | 6 | 7 | 8 | 9 | 10 | 11 | 12 |
| L [mm] | 190 | 245 | 300 | 355 | 410 | 465 | 520 | 575 | 630 | 685 | 740 |

The brackets of the heating manifold are mounted to the moveable C- rails via the prepared bolts or boreholes.

Connection to heating manifolds

Each manifold is fitted with a 1" male thread for mounting of the ball valves / filling set. These original parts can be mounted as self-sealing parts using flat sealing. We cannot assume liability or extend any warranty if external parts are used.

Flushing and filling the heating circuits

To flush and fill the heating circuits, fit hoses with 3/4" hose nozzles to the male thread of the filling cocks. Open / close the outlets by turning the handle or square hub. Each circuit should be flushed separately. Avoid high pressure difference (> 1 bar). The manifold should be operated with water. The heating circuits can be identified by attaching self-adhesive labels to the manifold block. This ensures correct assignment of the outlets of the manifold to the various rooms. The manifolds are factory-tested for seal-tightness (using the differential pressure method) and proper functioning. The testing pressure for the manifolds is 6 bar / 87 psi. The closing point of the valves is 11.8 mm.



Installation of the pipes

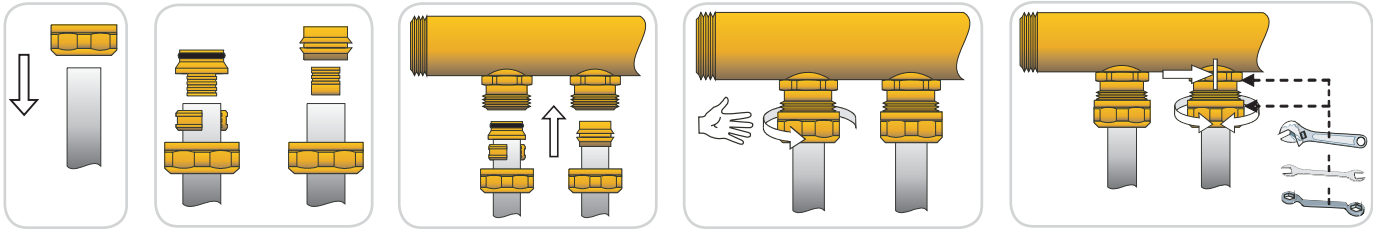

1. Cut the RADOPRESS floor heating pipe at the right angle and deburr / calibrate. Push the sleeve nut over the tube.
2. Push the clamping ring over the pipe and insert hose nozzle.
3. Insert the pre-assembled pipe into the screw connection.
4. Screw on the euro cone by hand. Push the pipe all the way till it stops.
5. Counter the outlet screw connection using an open-end wrench 24 mm and tighten the clamping ring nut using an open-end wrench 30 mm (Force approx. 25-30 Nm or 18 lb ft).

Rinsing and filling the circuits

Close the ball valves. Close all control valves by using the protective caps. Attach the fill- and drain hose to the filling joint in the supply. The discharge outlet must be open! All flow meters must be completely open! Close all control valves in the return, only the valve off of the circle which should be rinsed must be completely open! Flush the circles each by each with clear water. After rinsing close the control valve and rinse/fill the next circle. Remove the hose after end of the rinsing and filling procedure from the joint.

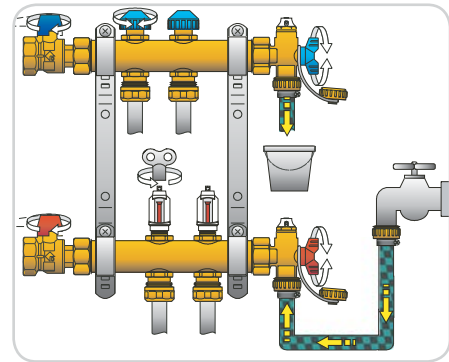

Setting of the flow control

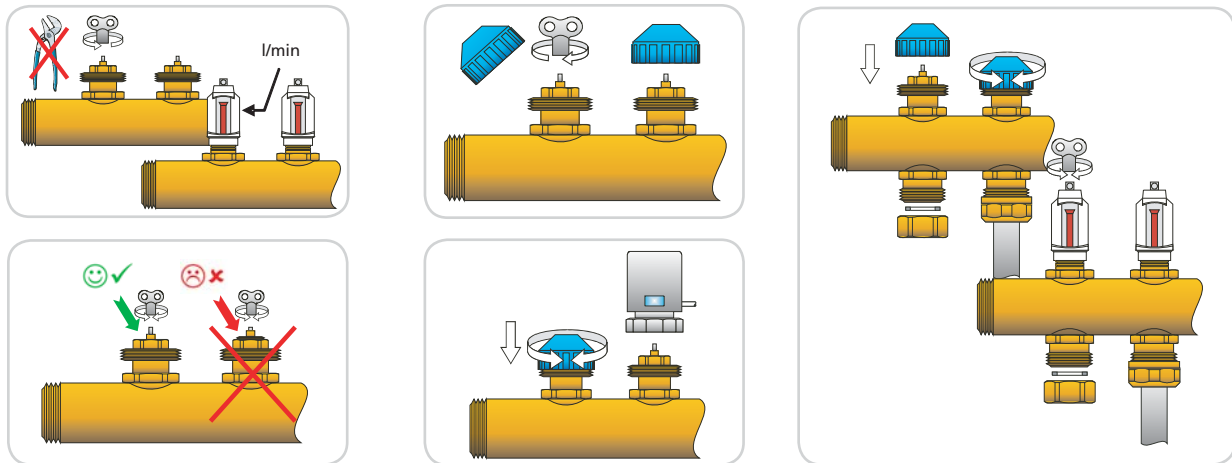

1. Remove the plastic cap and close the valve by turning to the right using a adjusting key (close = smallest volume).
 2. Adjust the required flow rate by turning the regulation spindle to the left. Read of the actual flow value at the flow meter. After all circuits were regulated, check the flow values and re-adjust if necessary.
 3. Assemble the protective cap respectively the actuator after completion of the setting. Thus you can prevent the valves from getting dirty and the setting of the flow is protected.
 4. The fine thread of the adjusting spindle must not be seen above the edge of the size 19 hex! Based on closed status, the valve is open (full flow) after 2,5 to 3 turns to the left.
 5. The valves in the return can be closed, e.g. for rinsing and filling the heating circuits. For that purposes put the protective cap on the valve and close it by turning clockwise. The flow meter can be closed with a bleed key. The flow meter is not applicable for flow adjustment.
- (*) For permanent shut-off a cap 3/4" incl. washers should be mounted to the connection piece on site.

If proportional drives are used, the regulating spindle must be opened at least 0,5 to 1 revolutions irrespective of the adjusted volume flow. The room temperature is then regulated via the actuator.

The IsoTherm mixing unit

Thermostatic low-temperature control unit for underfloor heating systems

Advantages of IsoTherm mixing unit

- Compact control unit, ready for installation
- Setting range from 30°C to 50°C or 45°C to 60°C to supply flow temperature
- Thermometer displays actual supply flow temperature
- Pump, TempGuard and high-temperature limiter are pre-mounted ex factory
- High temperature limiter
- All points of connection flat-sealed
- Fits all 1" heating circuit manifolds either to the left or right side
- Suitable for heat output requirements up to approx. 8-10 kW



Applications

The IsoTherm low-temperature control unit is used to ensure a constant supply flow temperature in low-temperature heating systems (underfloor/wall heating). The supply flow temperature can be set ungraded between 30°C ... 50°C and between 45°C ... 60°C on the control unit.

The IsoTherm is used in systems that provide heat to consumers with high supply temperature (e.g. radiators, air heaters etc.) as well as to consumers with low supply temperatures (e.g. underfloor / wall heating).

Considering comfort and construction-related aspects the surface temperature may not exceed 29°C in the dwell zone and 35°C in the border zone, the supply flow temperature for underfloor heating surfaces has to be maintained at an accordingly lower level regardless of the boiler temperature depending on time.

ADJUSTMENT OF THE UNDERFLOOR FLOW TEMPERATURE

In the event of maximum heat output demanded (rated output), the boiler flow temperature must be at least 15°C higher than the desired flow temperature in the underfloor circuit!

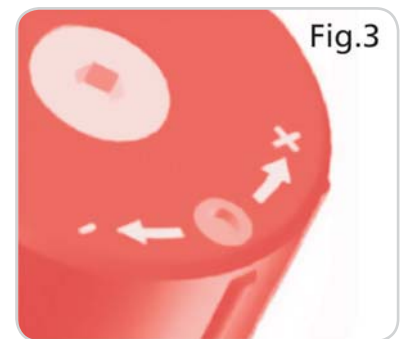

The flow temperature is factory-made set to the values mentioned above. The top of the pilot pin meets the face of the adjusting hand wheel (see Fig. 1) By turning the adjusting hand wheel in minus or plus direction the set flow temperature is changed accordingly. The hand wheel clicks with the rotation. Each "click" means a set temperature change of the desired value around 1 °C.

Decrease of the desired flow temperature: Turning the adjusting hand wheel in the clockwise direction. If the pilot pin moves out from the adjusting hand wheel, this entails a lower target temperature (see Fig. 2). Each "click" in the clockwise direction reduces the target temperature around 1 °C. The set range of temperature is from 30°C to 50 or 45 °C to 60 according to the type used. However, the adjusting hand wheel can be moved further up and down. Outside of the temperature range, this causes only small changes in the target temperature.

Increase of the desired flow temperature: Turning the adjusting hand wheel in the anti-clockwise direction. If the pilot pin moves into the hand wheel, this entails a higher target temperature (see Fig.3). Each "click" in the anti clockwise direction rises the target temperature around 1°C.



Design / Mode of operation

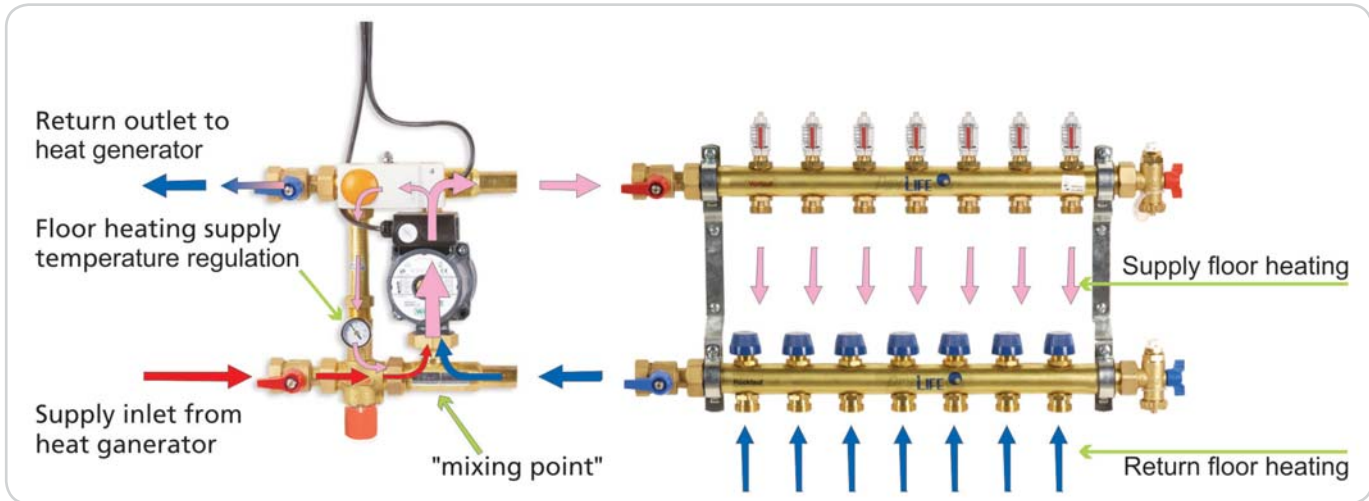

The IsoTherm low-temperature control unit is made up of precision-matched components with flat-seal connections. The target value for the supply flow temperature set on the TempGuard thermostatic mixing valve is continuously monitored by a sensor positioned directly in the volume flow. The mixing valve feeds a greater or less volume of hot water from the boiler circuit to the heating circuit manifold to balance out temperature deviations more or less instantly.

The "injected" hot water is directly mixed with the water coming from the return flow collector of the manifold and makes its way via the circulation pump and the supply flow manifold to the connected heating circuits. A high temperature limiter also installed in the supply flow branch switches the pump off immediately if the maximum temperature (e.g. 80°C) is exceeded. The bypass ensures a certain degree of continuous circulation that:

- a) passes on the actual supply flow temperature to the mixer valve on an ongoing basis.
- b) permits dissipation of differential pressure with closed heating circuits and continued operation of the pump (e.g. via pump logic) through the integrated overpressure shutoff.

Installation

The IsoTherm can be mounted either to the right or left on all heating circuit manifolds with 1" thread. All components are fitted with flat-seal screw connections. Using suitable accessories, the control unit can also be equipped with heat meters. Maximum comfort with minimum use of energy is achieved by installing an actuator on each control valve of the return manifold. This permits control of individual room temperatures as desired from the user.

Max. Admissible operating temperature: +90°C
 Min. Admissible operating temperature: -20°C*
 Max. Admissible operating pressure: 10bar



DRINKING AND SANITARY HOT WATER, CENTRAL HEATING AND FLOOR HEATING

5. CONTROLLING UNITS OF THE RADOPRESS SYSTEM

Controlling units of RADOPRESS system - regulates your heating system in the most efficient and energy saving way

Benefits of the Radopress regulation system:

- better thermal comfort
- energy savings
- even heat distribution
- professional controlled room temperature

Basic elements of RADOPRESS heating controlling system

All heating systems must have proper and correct controls to maintain and achieve comfortable living conditions, energy efficient operation and comply with current building regulations. To get the best results from your underfloor heating system Pipelife recommends individual control in each room. A room thermostat controls the actuators that open or close the pipe circuits specific to that area. The room thermostat system also takes into account all other heat sources including sunshine body temperature. There are various types of controls available from boiler controls through air temperature control to wireless control. Some controls offer various additions such as night setback facility, separate time and temperature controlled thermostats (i.e. programmable), wet area thermostats. Centralised wiring centre units are also included to provide the complete system control to include boilers radiators and domestic water.

Actuator

The thermoelectric actuator heads prepared for installation on heating circuit manifolds, with position indicator for control the opening and closing of a particular floor heating circuit on the manifold. Protection class IP 44. supply line 1m, max. ambient temperature 50°C, connection M30 x 1,5. The actuator keeps the valve closed (NC) or open (NO) when currentless.



Electronic room thermostat

The electronic room thermostat can be used to regulate the room temperature. Adjustment range 5 - 30°C, differential gap 0,5 K, operating temperature 0 - 50°C, noiseless triac contact, NTC temperature sensor, output 15 W, IP 30. Available with or without mode selection, reduced or pilot wire (clock timer).



Electronic room thermostat with digital display

Electronic room thermostat with three controlling mode:

1. via internal room sensor
2. via external room sensor (floor sensor)
3. via internal room sensor and floor temperature limitation

Adjustment range 5 - 30°C, differential gap 0,5 K, operating temperature 0 - 50°C, noiseless triac contact, NTC temperature sensor, output 15 W, IP 30. Mode selection normal, reduced or pilot wire (clock timer). Floor sensor with adjustable temperature limitation 10 - 40°C, 3 m sensor cable.



Clock thermostat Milux

Electronic clock thermostat with LCD display. Adjustment range 5 - 35°C for normal or reduction mode, 9 integrated standard programs and 4 variable user programs, antifreeze and holiday function, key lock, reset function. Output 8 A-250 VAC, 3 batteries with 1,5 V (AA), batteries weak display, protection class IP 30.





INHOUSE SYSTEM

Electronic room thermostat with tamper-proof setting

This type of thermo sensor can be installed in wet areas. Adjustment range 5 - 30°C, differential gap 0,5 K, operating temperature 0 - 50°C, noiseless triac contact, NTC temperature sensor, output 15 W, IP 30. Mode selection normal, reduced or pilot wire (clock timer). Floor sensor with adjustable temperature limitation 10 - 40°C, 3 m sensor cable.

3 control modes:

- 1) via internal room sensor.
- 2) via external room sensor (floor sensor).
- 3) via internal room sensor and floor temperature limitation.



Connecting box, Master

The connecting Box master is a 4-zone wiring centre with all main connections for an underfloor heating system. This is usually mounted on the wall or on a C-rail close to the manifold, and connects the room thermostats to their corresponding actuators. The states of the actuators, pump and boiler are indicated in the side of the box by LED's. The operating temperature 0 - 50°C, pump relay (output 8 A), IP 30, modular design.



Connecting box, Slave

This 4 or 6 zone slave unit is used for combination with and/or as extension of the connecting box Master. Operating temperature 0 - 50°C, IP 30, modular design.



Digital clock timer

The fully programmable Digital clock timer has 7 days programming, LCD display, 2 time/temperature channels, 3 hours power reserve. Non-volatile program memory. Can be combined with connecting box Master and/or Slave. Operating temperature 0 - 50°C, IP 30.



RF controlling units

By using Radio Frequency (RF) controlled system, we do not need cables to place and install individual room thermostats. It can speed up the installation process of the controlling system. Each room thermostat have an own Radio Frequency in which they can communicate with the RF-connecting Box Master. This units has a distribution range of approx 50m and the signal is received through an attached antenna. It receives the signal from the RF room thermostat and opens and close the thermoelectric actuator accordingly. This whole unit can be placed near the manifold and the only hard wired connections to it are the actuators and power supply.

RF-Thermostat with digital display

Adjustment range 5 - 30°C, differential gap 0,3 K, operating temperature 0 - 50°C, open ground distance 50 m, frequency 433 MHz, operating voltage 2 lithium batteries with 3 V (CR 2430), battery life time 2 years.





DRINKING AND SANITARY HOT WATER, CENTRAL HEATING AND FLOOR HEATING

RF-Clock thermostat MILUX-RF

RF-Thermostat with LCD display. Adjustment range 5 - 35°C for normal or reduction mode, 9 integrated standard programs and 4 variable user programs, antifreeze and holiday function, key lock. Frequency 433 MHz, open ground distance 100 m, 3 batteries with 1,5 V (AA), batteries weak display, protection class IP 30. Receiver (included): 230 VAC, output 12 A, protection class IP 44.



RF-Connecting box, Slave

Operating temperature 0 - 50°C, IP 30, for normally open (NO) or normally closed (NC) actuators. Operation only when used with RF-Connecting box, Master with Receiver and Timer!



RF-Receiver and Timer

Operating temperature 0 - 50°C, IP 30, external antenna with 1,5 m feed cable and plug, LCD display, pump anti-block function, normal, reduction or antifreeze mode, 9 integrated standard programs and 12 variable user programs, holiday function, ITCS.

RF-Connecting box, Master with Receiver and Timer

Operating temperature 0 - 50°C, pump relay (2 outputs, each 8 A), IP 30, for normally open (NO) or normally closed (NC) actuators. The radio signal is received by a RF Receiver and Timer. Technical specifications of the receiver see product RF-Receiver and Timer.



RF-Receiver for 1 zone

Receiver for all RF-Thermostats. Using one RF-Thermostat as transmitter, multiple Receiver can be operated. Switch for automatic/operating mode and radio configuration. Output 13 A, protection class IP 44. Frequency 433 MHz.





INHOUSE SYSTEM

The working method of the regulation

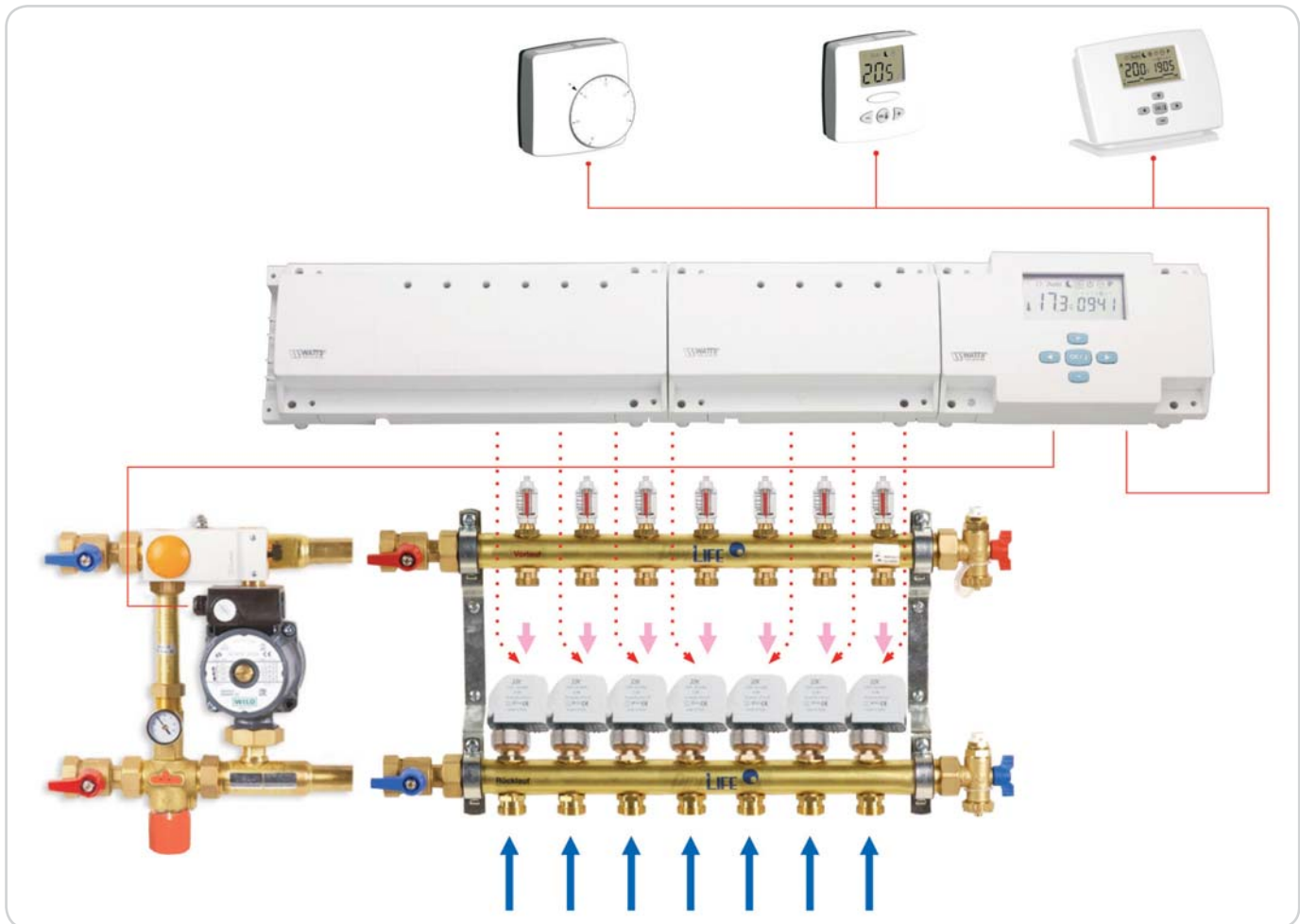

The Master 6 zones is a connecting box with all the main electrical connections for floor heating system. This box can be adapted either on a C rail or directly on a wall. It connects room thermostats to their corresponding actuators. The state of the actuators are indicated by individual Leds. The pilot wire of thermostats can be controlled by an external timer. As soon as we have a heat demand from one zone a relay with two volt free contacts is switch on (Pump, Boiler or other possible connection). Possibility to add more zones by plugging Slave 230V connecting box.

5. TOOLS

We are offering high quality tools which are the most suitable for the installation of our product range

RADOPRESS pressing machines

There are two types of pressing machines available.

Battery driven pressing machines

Battery driven pressing machines are the most frequently used devices. They are compact, portable and lightweight, energized by a storage battery, and weight only 4.5 kg therefore, they are useful anywhere. Rotary fastening of pressing jaws will enable you to work even at highly accessible places. Depending on dimensions, we can make approx. 150 pressing with one charging, independently from the electrical network. It is supplied with steel case, with a charger and a battery. In the case, there is also space for replacement battery and for 3 pressing jaws.



Pressing machines energized from the electrical network of 230 V

This is an electrical radial press of breaking electronics, serving for the production of pressed connections with the diameter of 10-76 (108) mm. It weights 4.8 kg and the device is also delivered in steel case where the place for five pressing jaws is available. Although it is cheaper, it requires electricity connection.



Manual pressing tools

Small dimensions of the fittings (D16-26) can be pressed by using manual pressing tools. The weight of the tool is only 1.6 kg. We can increase the pressing force by using pipe shanks.



Pressing jaws RADOPRESS - with TH profile

RADOPRESS pressing jaws are suitable for most of the pressing machines available on the market. If you already have other pressing tools, make sure if you can use the pressing jaws RADOPRESS together with it. The pressing jaws are available in the following dimensions: D16, D18, D20, D26, D32, D40, D50 and D63.



Tool case

In the pressing machine tool case, there are free spaces for the jaws. If you need a wider assortment of the pressing jaws, we can offer a separate tool case for 6 jaws.



Calibration tools

For every dimension from D16 to D63, a separate calibrator is available. The calibrator can be used manually, or after removing the holder and fastening it into a drilling machine.

Bending spring

The RADOPRESS multilayer pipes Pipelife may be freely bended, with the bend radius 5xD. In D16 mm pipe this corresponds to the radius of 8 cm.

Inner bending spring - in some cases small bended radiuses are needed (especially in heater connections), a bending spring is used. With it you may reach the bending radius of 3.5xD. In a D16 mm pipe this corresponds to a radius of 5.6 cm.

Outer bending spring - for special purposes such as plate heating, the outer bending spring is available.



Tool service

Inspect the status of your pressing jaws with regard to cracks and wear on a regular basis. Once a year let the producer check the pressing devices and pressing jaws. Perfect status of your tools is an essential assumption of safe pressing.

6. MOUNTING INSTRUCTIONS

Neither welding nor soldering as long as you connect the pipeline fast and precisely

1. Shorten the pipe to the length required by using shears, under the angle of 90°C (upright) in respect to the central axis.
2. Removing frays and calibration - slip the calibrator of the corresponding diameter completely into the pipe and, simultaneously, turn clockwise. This way the pipe end is calibrated and the edge is chamfered. In the end of the operating sequence remove possible chippings from the pipe end. Check the pipe end regarding cleanness and perfect deeding (the contour chamfer with the angle of 15° is seen).
IMPORTANT: The chamfer must be present on the periphery, thus preventing O-rings protrusion.
3. Slip a suitable as far as to the pipe backstop. Through the controlling holes on the pressing skeve it can be seen if the pipe is inserted into the fitting in the requested depth.
4. Slip the pressing jaw with its wide slot to the fitting plastic ring.
ATTENTION! Only a clean, not damaged pressing jaw enables perfect pressing.
5. Turn on the pressing machine - the pressing procedure is successfully finished as soon as the complete jaw closing is reached. Pressing notches must be located equally and on the whole perimeter.
6. Pressing control:
 - Through controlling holes on the pressing sleeve there can be seen the minimum depth of pipe insertion.
 - On the pressing sleeve periphery, two parallel round forcing-in marks can be seen.
 - Between both round pressing marks, a camber is visible in a parallel way.

ATTENTION - over the pressing sleeve end, the whole compressed pipe has to be straight and over the forcing-in it must not be bent in the distance of at least 1 x D.

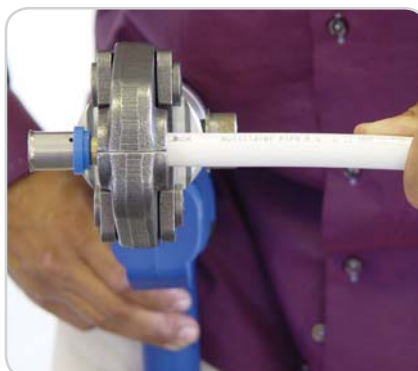
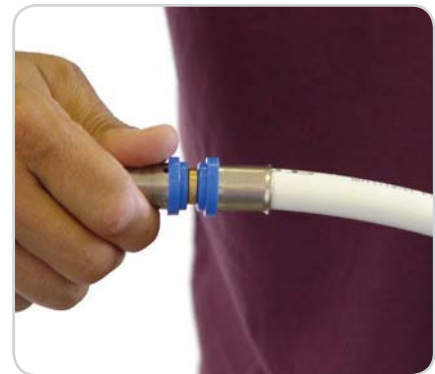

7. WARRANTY

We offering a high quality system! This is guaranteed by our longtime warranty!

For all elements of the RADOPRESS system, the company Pipelife provides with a 10-year warranty of quality. In addition, in case of an authenticated material failure of any elements of the system, the company also avouches possible operating damages. The warranty applies to the whole distribution, if it is made up of components of the RADOPRESS system, i.e. especially of pipes and fittings, with observing specific storage directions, assembly methods, valid technical regulations and standards.

8. Manipulation, storage

- The elements of RADOPRESS system must not be stored in free atmosphere; they must not be exposed to permanent direct sunlight and weather factors.
- They must be placed in a shed, in dry and dust-free surroundings.
- They must not be stored together with organic solvents, products containing solvents and other chemicals without a warranty of inactivity in respect to the stored material (gasoline, oil, sulfuric agents, ...)
- They must not be exposed to thermal radiation; the distance from the heat source must be at least 1 m.
- The pipes are stored in rolls or cartons as they are delivered.
- The temperature in stocks must not exceed +40°C.
- At temperatures below 0°C, special care should be taken of manipulation.
- During storage and manipulation they must not be permanently unilaterally loaded or bent leant on sharp edges.
- The pipes made as straight rods must be stored in horizontal position, at least 0.10 m above the floor; they can be stunk up to the maximum height of 0.60 m.
- The pipes (coils) must be stored in horizontal position, at least 0.10 m above floor; ten rolls on each other at a maximum.
- In the elements of the RADOPRESS system no packaging damage may occur.
- During the manipulation, separated elements must not be slide on the ground nor worn by sharp objects; it is necessary to avoid forceful impacts on manipulation.
- During material acceptance, the followings are controlled:
 - Quantity, compliance with documentation
 - General appearance, material or packaging integrity
 - Spot check of specified dimensional tolerances

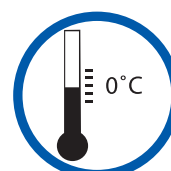
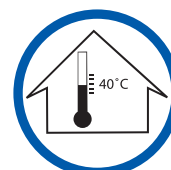

9. DESIGN SUPPORT

Our Service Centre will propose requested distribution on a professional level for you.

Our Service Centre is available for you and is planned for your convenience. According to your submission the Center will propose and design the distribution of drinking and hot water (including circulation), central and floor heating using the system RADOPRESS. The specification of the system components that are needed and the drawing documentation is included as self-evident. The calculation diagram used in this Service Centre is also available at our contractual designers. If you are interested, please ask our company salesmen or directly contact the Service Centre on its e-mail address: radopress@pipelife.com.

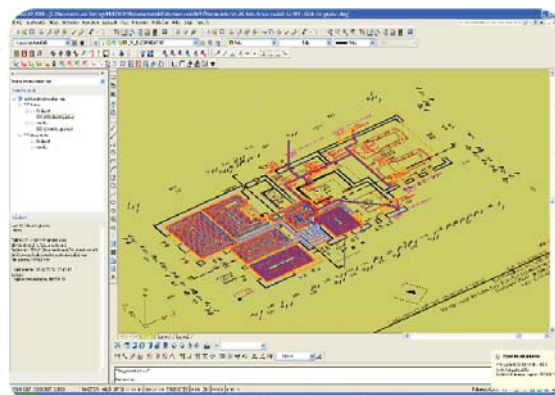



10. TABLES

Are you interested in further technical parameters of the RADOPRESS system? Here they are!

Head losses in pipes

During designing devices, head losses of used modules in relation to flow have to be taken into account. You may read values of head losses for multilayered pipes Pipelife RADOPRESS from the diagram.

The basis of head losses specification is a definition of the mass flow rate:

$$m = \frac{Q}{1,163 \times \Delta\theta} \text{ [kg / h]}$$

Where Q = heating body output in watts, $\Delta\theta$ = temperature difference in Kelvins.

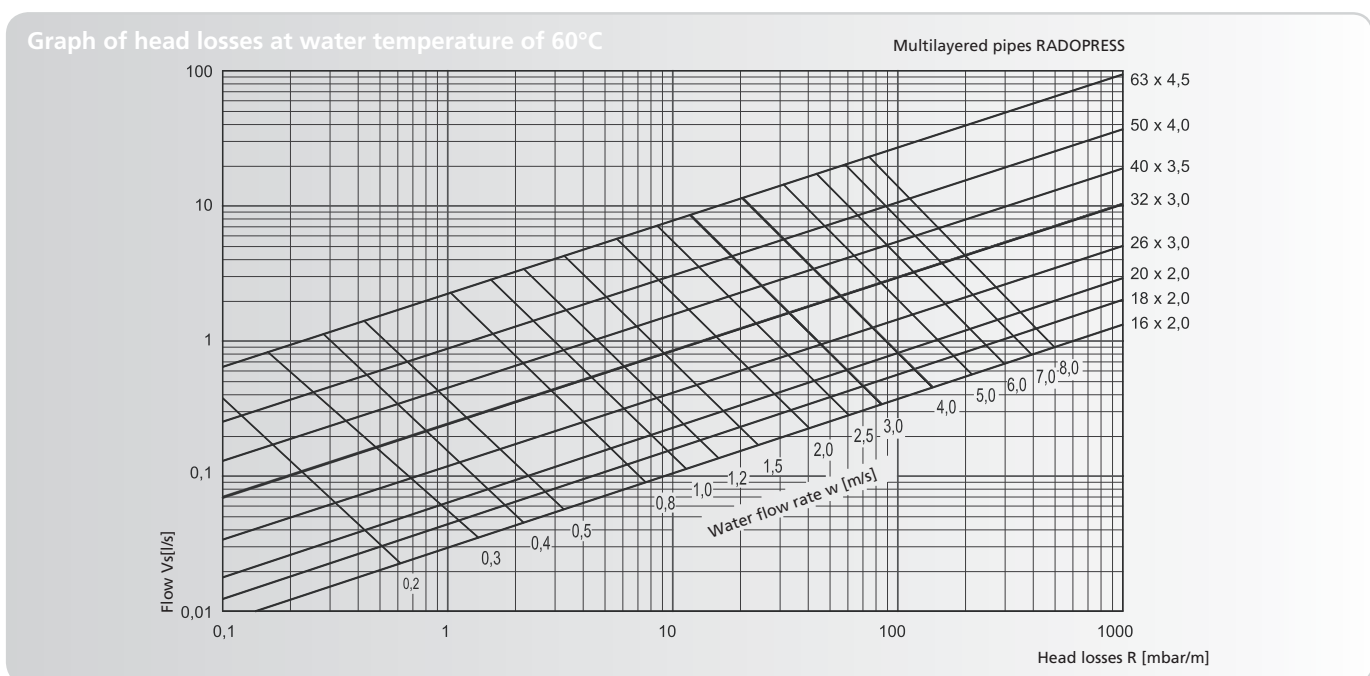
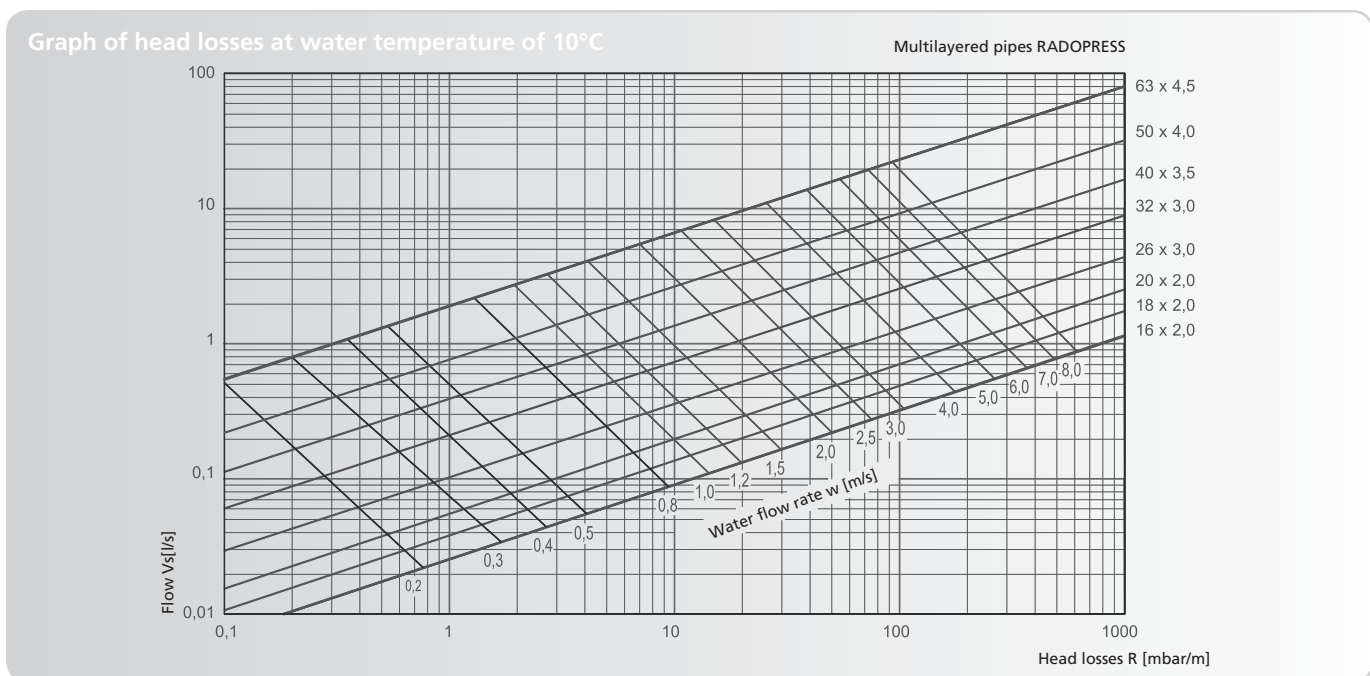

DRINKING AND SANITARY HOT WATER, CENTRAL HEATING AND FLOOR HEATING

Summary of head losses R in RADOPRESS pipes Installation of drinking and hot water

Multilayered pipes (PEX-Al-PEX)

| w | 16 x 2,0 mm | | 20 x 2,0 mm | | 26 x 3,0 mm | | 32 x 3,0 mm | | 40 x 3,5 mm | | 50 x 4,0 mm | | 63 x 4,5 mm | |
|------|-------------|-------------|-------------|-------------|-------------|-------------|-------------|------------|-------------|------------|-------------|-------------|-------------|-------------|
| | Vs m/s | R mbar/m | Vs l/s | R mbar/m | Vs l/s | R mbar/m | Vs l/s m | R bar/m | Vs l/s m | R bar/m | Vs l/s | R mbar/m | Vs l/s | R mbar/m |
| 0,10 | 0,01 | 0,18 | 0,02 | 0,14 | 0,03 | 0,10 | 0,05 | 0,07 | 0,09 | 0,05 | 0,14 | 0,04 | 0,23 | 0,02 |
| 0,15 | 0,02 | 0,37 | 0,03 | 0,28 | 0,05 | 0,20 | 0,08 | 0,14 | 0,13 | 0,11 | 0,21 | 0,08 | 0,34 | 0,05 |
| 0,20 | 0,02 | 0,61 | 0,04 | 0,47 | 0,06 | 0,33 | 0,11 | 0,24 | 0,17 | 0,18 | 0,28 | 0,13 | 0,46 | 0,09 |
| 0,25 | 0,03 | 0,91 | 0,05 | 0,69 | 0,08 | 0,49 | 0,13 | 0,35 | 0,21 | 0,26 | 0,35 | 0,19 | 0,57 | 0,15 |
| 0,30 | 0,04 | 1,25 | 0,05 | 0,95 | 0,09 | 0,67 | 0,16 | 0,48 | 0,26 | 0,36 | 0,42 | 0,27 | 0,69 | 0,21 |
| 0,35 | 0,04 | 1,36 | 0,06 | 1,24 | 0,11 | 0,88 | 0,19 | 0,63 | 0,30 | 0,47 | 0,48 | 0,36 | 0,80 | 0,28 |
| 0,40 | 0,05 | 2,06 | 0,07 | 1,57 | 0,13 | 1,11 | 0,21 | 0,80 | 0,34 | 0,59 | 0,55 | 0,44 | 0,92 | 0,37 |
| 0,45 | 0,05 | 2,54 | 0,08 | 1,93 | 0,14 | 1,37 | 0,24 | 0,99 | 0,38 | 0,73 | 0,62 | 0,54 | 1,03 | 0,47 |
| 0,50 | 0,06 | 3,05 | 0,09 | 2,32 | 0,16 | 1,64 | 0,27 | 1,18 | 0,43 | 0,88 | 0,69 | 0,65 | 1,15 | 0,58 |
| 0,55 | 0,06 | 3,60 | 0,10 | 2,74 | 0,17 | 1,94 | 0,29 | 1,40 | 0,47 | 1,04 | 0,76 | 0,77 | 1,26 | 0,70 |
| 0,60 | 0,07 | 4,20 | 0,11 | 3,19 | 0,19 | 2,26 | 0,32 | 1,63 | 0,51 | 1,21 | 0,83 | 0,89 | 1,37 | 0,84 |
| 0,65 | 0,08 | 4,83 | 0,12 | 3,67 | 0,20 | 2,60 | 0,35 | 1,87 | 0,56 | 1,39 | 0,90 | 1,03 | 1,49 | 0,98 |
| 0,70 | 0,08 | 5,50 | 0,13 | 4,18 | 0,22 | 2,96 | 0,37 | 2,13 | 0,60 | 1,60 | 0,97 | 1,17 | 1,60 | 1,14 |
| 0,75 | 0,09 | 6,20 | 0,14 | 4,71 | 0,24 | 3,34 | 0,40 | 2,41 | 0,64 | 1,79 | 1,04 | 1,32 | 1,72 | 1,31 |
| 0,80 | 0,09 | 6,94 | 0,15 | 5,27 | 0,25 | 3,74 | 0,42 | 2,70 | 0,68 | 2,00 | 1,11 | 1,48 | 1,83 | 1,49 |
| 0,85 | 0,10 | 7,72 | 0,15 | 5,86 | 0,27 | 4,16 | 0,45 | 3,00 | 0,73 | 2,23 | 1,18 | 1,65 | 1,95 | 1,68 |
| 0,90 | 0,11 | 8,53 | 0,16 | 6,48 | 0,28 | 4,60 | 0,48 | 3,31 | 0,77 | 2,46 | 1,25 | 1,80 | 2,06 | 1,88 |
| 0,95 | 0,11 | 9,38 | 0,17 | 7,13 | 0,30 | 5,06 | 0,50 | 3,64 | 0,81 | 2,70 | 1,32 | 2,00 | 2,18 | 2,10 |
| 1,00 | 0,12 | 10,26 | 0,18 | 7,79 | 0,31 | 5,53 | 0,53 | 3,98 | 0,86 | 2,96 | 1,39 | 2,19 | 2,29 | 2,33 |
| 1,10 | 0,13 | 12,12 | 0,20 | 9,21 | 0,35 | 6,53 | 0,58 | 4,71 | 0,94 | 3,49 | 1,52 | 2,58 | 2,52 | 2,81 |
| 1,20 | 0,14 | 14,12 | 0,22 | 10,72 | 0,38 | 7,61 | 0,64 | 5,48 | 1,03 | 4,07 | 1,66 | 3,01 | 2,75 | 3,35 |
| 1,30 | 0,15 | 16,24 | 0,24 | 12,34 | 0,41 | 8,75 | 0,69 | 6,31 | 1,11 | 4,68 | 1,80 | 3,46 | 2,98 | 3,93 |
| 1,40 | 0,16 | 18,49 | 0,25 | 14,04 | 0,44 | 9,97 | 0,74 | 7,18 | 1,20 | 5,33 | 1,94 | 3,94 | 3,21 | 4,56 |
| 1,50 | 0,18 | 20,86 | 0,27 | 15,85 | 0,47 | 11,24 | 0,80 | 8,10 | 1,28 | 6,01 | 2,08 | 4,45 | 3,44 | 5,23 |
| 1,60 | 0,19 | 23,35 | 0,29 | 17,74 | 0,50 | 12,59 | 0,85 | 9,07 | 1,37 | 6,73 | 2,22 | 4,98 | 3,66 | 5,95 |
| 1,70 | 0,20 | 25,97 | 0,31 | 19,73 | 0,53 | 14,00 | 0,90 | 10,08 | 1,45 | 7,49 | 2,36 | 5,54 | 3,89 | 6,72 |
| 1,80 | 0,21 | 28,70 | 0,33 | 21,80 | 0,57 | 15,47 | 0,96 | 11,15 | 1,54 | 8,27 | 2,49 | 6,12 | 4,12 | 7,53 |
| 1,90 | 0,22 | 31,55 | 0,34 | 23,97 | 0,60 | 17,01 | 1,01 | 12,25 | 1,63 | 9,09 | 2,63 | 6,73 | 4,35 | 8,39 |
| 2,00 | 0,23 | 34,51 | 0,36 | 26,22 | 0,63 | 18,60 | 1,06 | 13,40 | 1,71 | 9,95 | 2,77 | 7,36 | 4,58 | 9,30 |
| 2,10 | 0,25 | 37,58 | 0,38 | 28,55 | 0,66 | 20,26 | 1,11 | 14,60 | 1,80 | 10,83 | 2,91 | 8,01 | 4,81 | 10,25 |
| 2,20 | 0,26 | 40,77 | 0,40 | 30,97 | 0,69 | 21,98 | 1,17 | 15,83 | 1,88 | 11,75 | 3,05 | 8,69 | 5,04 | 11,25 |
| 2,30 | 0,27 | 44,07 | 0,42 | 33,48 | 0,72 | 23,76 | 1,20 | 17,12 | 1,97 | 12,70 | 3,19 | 9,40 | 5,27 | 12,30 |
| 2,40 | 0,28 | 47,48 | 0,44 | 36,07 | 0,75 | 25,60 | 1,27 | 18,44 | 2,05 | 13,69 | 3,32 | 10,12 | 5,50 | 13,39 |
| 2,50 | 0,29 | 50,99 | 0,45 | 38,74 | 0,79 | 27,49 | 1,33 | 19,88 | 2,14 | 14,70 | 3,46 | 10,87 | 5,73 | 14,53 |
| 2,60 | | | | | 0,82 | 29,44 | 1,38 | 21,21 | 2,22 | 15,74 | 3,60 | 11,65 | 5,95 | 15,72 |
| 2,70 | | | | | 0,85 | 31,45 | 1,43 | 22,66 | 2,31 | 16,82 | 3,74 | 12,44 | 6,18 | 16,95 |
| 2,80 | | | | | 0,88 | 33,52 | 1,49 | 24,15 | 2,39 | 17,92 | 3,88 | 13,26 | 6,41 | 18,23 |
| 2,90 | | | | | 0,91 | 35,64 | 1,54 | 25,68 | 2,48 | 19,06 | 4,02 | 14,10 | 6,64 | 19,55 |
| 3,00 | | | | | 0,94 | 37,82 | 1,59 | 27,25 | 2,57 | 20,22 | 4,16 | 14,96 | 6,87 | 20,93 |
| 3,60 | | | | | 1,13 | 52,04 | 1,91 | 37,49 | 3,08 | 27,83 | 4,99 | 20,58 | 8,24 | 30,13 |
| 4,00 | | | | | 1,26 | 62,57 | 2,12 | 45,08 | 3,42 | 33,46 | 5,54 | 24,75 | 9,16 | 37,20 |
| 4,60 | | | | | 1,45 | 79,91 | 2,44 | 57,57 | 3,93 | 42,73 | 6,37 | 31,61 | 10,53 | 49,20 |
| 5,00 | | | | | 1,57 | 92,47 | 2,65 | 66,61 | 4,28 | 49,44 | 6,93 | 36,58 | 11,45 | 58,13 |



INHOUSE SYSTEM

Summary of head losses in RADOPRESS pipes

Multilayered pipes (PEX-Al-PEX)

| Power requirement [W] | | | | Mass flow rate m | Head losses in pipe by friction R [mbar/m] | | | | | | | | | | | |
|-----------------------|-------|-------|-------|---------------------|--|--------|------|-------------|--------|------|-------------|--------|------|-------------|--------|------|
| Temperature gradient | | | | | 16 x 2,0 mm | | | 20 x 2,0 mm | | | 26 x 3,0 mm | | | 32 x 3,0 mm | | |
| 20 K | 15 K | 10 K | 5 K | kg/h | m/s | mbar/m | Pa/m | m/s | mbar/m | Pa/m | m/s | mbar/m | Pa/m | m/s | mbar/m | Pa/m |
| 200 | 150 | 100 | 50 | 9 | 0,0 | 0,01 | 1 | | | | | | | | | |
| 300 | 225 | 150 | 75 | 13 | 0,0 | 0,02 | 2 | | | | | | | | | |
| 400 | 300 | 200 | 100 | 17 | 0,0 | 0,04 | 4 | | | | | | | | | |
| 600 | 450 | 300 | 150 | 26 | 0,1 | 0,08 | 8 | | | | | | | | | |
| 800 | 600 | 400 | 200 | 34 | 0,1 | 0,14 | 14 | | | | | | | | | |
| 1000 | 750 | 500 | 250 | 43 | 0,1 | 0,21 | 21 | | | | | | | | | |
| 1200 | 900 | 600 | 300 | 52 | 0,1 | 0,28 | 28 | | | | | | | | | |
| 1400 | 1050 | 700 | 350 | 60 | 0,2 | 0,37 | 37 | | | | | | | | | |
| 1600 | 1200 | 800 | 400 | 69 | 0,2 | 0,47 | 47 | | | | | | | | | |
| 1800 | 1350 | 900 | 450 | 77 | 0,2 | 0,57 | 57 | | | | | | | | | |
| 2000 | 1500 | 1000 | 500 | 86 | 0,2 | 0,69 | 69 | 0,1 | 0,24 | 24 | | | | | | |
| 2300 | 1725 | 1150 | 575 | 99 | 0,2 | 0,88 | 88 | 0,2 | 0,31 | 31 | | | | | | |
| 2500 | 1875 | 1250 | 625 | 108 | 0,3 | 1,02 | 102 | 0,2 | 0,35 | 35 | | | | | | |
| 2800 | 2100 | 1400 | 700 | 120 | 0,3 | 1,24 | 124 | 0,2 | 0,43 | 43 | | | | | | |
| 3000 | 2250 | 1500 | 750 | 129 | 0,3 | 1,40 | 140 | 0,2 | 0,49 | 49 | | | | | | |
| 3500 | 2625 | 1750 | 875 | 151 | 0,4 | 1,84 | 184 | 0,2 | 0,64 | 64 | | | | | | |
| 4000 | 3000 | 2000 | 1000 | 172 | 0,4 | 2,32 | 232 | 0,3 | 0,80 | 80 | 0,2 | 0,21 | 21 | | | |
| 4500 | 3375 | 2250 | 1125 | 194 | 0,5 | 2,85 | 285 | 0,3 | 0,99 | 99 | 0,2 | 0,25 | 25 | | | |
| 5000 | 3750 | 2500 | 1250 | 215 | 0,5 | 3,43 | 343 | 0,3 | 1,19 | 119 | 0,2 | 0,30 | 30 | | | |
| 5500 | 4125 | 2750 | 1375 | 237 | 0,6 | 4,05 | 405 | 0,4 | 1,40 | 140 | 0,2 | 0,36 | 36 | | | |
| 6000 | 4500 | 3000 | 1500 | 258 | 0,6 | 4,72 | 472 | 0,4 | 1,64 | 164 | 0,2 | 0,42 | 42 | | | |
| 6500 | 4875 | 3250 | 1625 | 280 | 0,7 | 5,43 | 543 | 0,4 | 1,88 | 188 | 0,3 | 0,48 | 48 | | | |
| 7000 | 5250 | 3500 | 1750 | 301 | 0,8 | 6,18 | 618 | 0,5 | 2,14 | 214 | 0,3 | 0,55 | 55 | 0,2 | 0,16 | 16 |
| 7500 | 5625 | 3750 | 1875 | 323 | 0,8 | 6,97 | 697 | 0,5 | 2,42 | 242 | 0,3 | 0,62 | 62 | 0,2 | 0,18 | 18 |
| 8000 | 6000 | 4000 | 2000 | 344 | | | | 0,6 | 2,71 | 271 | 0,3 | 0,69 | 69 | 0,2 | 0,20 | 20 |
| 8500 | 6375 | 4250 | 2125 | 366 | | | | 0,6 | 3,01 | 301 | 0,3 | 0,77 | 77 | 0,2 | 0,22 | 22 |
| 9000 | 6750 | 4500 | 2250 | 387 | | | | 0,6 | 3,32 | 332 | 0,3 | 0,85 | 85 | 0,2 | 0,24 | 24 |
| 9500 | 7125 | 4750 | 2375 | 409 | | | | 0,7 | 3,65 | 365 | 0,4 | 0,93 | 93 | 0,2 | 0,27 | 27 |
| 10000 | 7500 | 5000 | 2500 | 430 | | | | 0,7 | 4,00 | 400 | 0,4 | 1,02 | 102 | 0,2 | 0,29 | 29 |
| 10500 | 7875 | 5250 | 2625 | 452 | | | | 0,7 | 4,35 | 435 | 0,4 | 1,11 | 111 | 0,2 | 0,32 | 32 |
| 11000 | 8250 | 5500 | 2750 | 473 | | | | 0,8 | 4,72 | 472 | 0,4 | 1,20 | 120 | 0,3 | 0,35 | 35 |
| 11500 | 8625 | 5750 | 2875 | 495 | | | | 0,8 | 5,11 | 511 | 0,4 | 1,30 | 130 | 0,3 | 0,37 | 37 |
| 12500 | 9375 | 6250 | 3125 | 538 | | | | | | | 0,5 | 1,51 | 151 | 0,3 | 0,43 | 43 |
| 13000 | 9750 | 6500 | 3250 | 559 | | | | | | | 0,5 | 1,61 | 161 | 0,3 | 0,46 | 46 |
| 14000 | 10500 | 7000 | 3500 | 602 | | | | | | | 0,5 | 1,84 | 184 | 0,3 | 0,53 | 53 |
| 15000 | 11250 | 7500 | 3750 | 645 | | | | | | | 0,6 | 2,07 | 207 | 0,3 | 0,60 | 60 |
| 16000 | 12000 | 8000 | 4000 | 688 | | | | | | | 0,6 | 2,32 | 232 | 0,4 | 0,67 | 67 |
| 17000 | 12750 | 8500 | 4250 | 731 | | | | | | | 0,7 | 2,58 | 258 | 0,4 | 0,74 | 74 |
| 18000 | 13500 | 9000 | 4500 | 775 | | | | | | | 0,7 | 2,85 | 285 | 0,4 | 0,82 | 82 |
| 19000 | 14250 | 9500 | 4750 | 818 | | | | | | | 0,7 | 3,13 | 313 | 0,4 | 0,90 | 90 |
| 20000 | 15000 | 10000 | 5000 | 861 | | | | | | | 0,8 | 3,43 | 343 | 0,5 | 0,99 | 99 |
| 22000 | 16500 | 11000 | 5500 | 947 | | | | | | | | | | 0,5 | 1,17 | 117 |
| 24000 | 18000 | 12000 | 6000 | 1033 | | | | | | | | | | 0,6 | 1,36 | 136 |
| 26000 | 19500 | 13000 | 6500 | 1119 | | | | | | | | | | 0,6 | 1,56 | 156 |
| 28000 | 21000 | 14000 | 7000 | 1205 | | | | | | | | | | 0,6 | 1,78 | 178 |
| 30000 | 22500 | 15000 | 7500 | 1291 | | | | | | | | | | 0,7 | 2,00 | 200 |
| 32000 | 24000 | 16000 | 8000 | 1377 | | | | | | | | | | 0,7 | 2,24 | 224 |
| 34000 | 25500 | 17000 | 8500 | 1463 | | | | | | | | | | 0,8 | 2,50 | 250 |
| 36000 | 27000 | 18000 | 9000 | 1549 | | | | | | | | | | 0,8 | 2,76 | 276 |
| 38000 | 28500 | 19000 | 9500 | 1635 | | | | | | | | | | 0,9 | 3,03 | 303 |
| 40000 | 30000 | 20000 | 10000 | 1721 | | | | | | | | | | 0,9 | 3,32 | 332 |
| 42000 | 31500 | 21000 | 10500 | 1807 | | | | | | | | | | 1,0 | 3,61 | 361 |
| 44000 | 33000 | 22000 | 11000 | 1893 | | | | | | | | | | 1,0 | 3,92 | 392 |
| 46000 | 34500 | 23000 | 11500 | 1979 | | | | | | | | | | | | |
| 48000 | 36000 | 24000 | 12000 | 2065 | | | | | | | | | | | | |
| 50000 | 37500 | 25000 | 12500 | 2151 | | | | | | | | | | | | |
| 52000 | 39000 | 26000 | 13000 | 2238 | | | | | | | | | | | | |
| 54000 | 40500 | 27000 | 13500 | 2324 | | | | | | | | | | | | |
| 56000 | 42000 | 28000 | 14000 | 2410 | | | | | | | | | | | | |
| 58000 | 43500 | 29000 | 14500 | 2496 | | | | | | | | | | | | |
| 60000 | 45000 | 30000 | 15000 | 2582 | | | | | | | | | | | | |
| 62000 | 46500 | 31000 | 15500 | 2668 | | | | | | | | | | | | |
| 64000 | 48000 | 32000 | 16000 | 2754 | | | | | | | | | | | | |
| 66000 | 49500 | 33000 | 16500 | 2840 | | | | | | | | | | | | |
| 68000 | 51000 | 34000 | 17000 | 2926 | | | | | | | | | | | | |
| 70000 | 52500 | 35000 | 17500 | 3012 | | | | | | | | | | | | |
| 72000 | 54000 | 36000 | 18000 | 3098 | | | | | | | | | | | | |

DRINKING AND SANITARY HOT WATER, CENTRAL HEATING AND FLOOR HEATING

Summary of head losses in RADOPRESS pipes

Multilayered pipes (PEX-Al-PEX)

| Power requirement [W] | | | | Mass flow rate m | Head losses in pipe by friction R [mbar/m] | | | | | | | | |
|-----------------------|--------|--------|-------|---------------------|--|--------|------|-------------|--------|------|-------------|--------|------|
| Temperature gradient | | | | | 40 x 3,5 mm | | | 50 x 4,0 mm | | | 63 x 4,5 mm | | |
| 20 K | 15 K | 10 K | 5 K | kg/h | m/s | mbar/m | Pa/m | m/s | mbar/m | Pa/m | m/s | mbar/m | Pa/m |
| 7500 | 5625 | 3750 | 1875 | 323 | | | | | | | | | |
| 8000 | 6000 | 4000 | 2000 | 344 | | | | | | | | | |
| 8500 | 6375 | 4250 | 2125 | 366 | | | | | | | | | |
| 9000 | 6750 | 4500 | 2250 | 387 | | | | | | | | | |
| 9500 | 7125 | 4750 | 2375 | 409 | | | | | | | | | |
| 10000 | 7500 | 5000 | 2500 | 430 | | | | | | | | | |
| 10500 | 7875 | 5250 | 2625 | 452 | | | | | | | | | |
| 11000 | 8250 | 5500 | 2750 | 473 | 0,2 | 0,11 | 11 | | | | | | |
| 11500 | 8625 | 5750 | 2875 | 495 | 0,2 | 0,12 | 12 | | | | | | |
| 12500 | 9375 | 6250 | 3125 | 538 | 0,2 | 0,14 | 14 | | | | | | |
| 13000 | 9750 | 6500 | 3250 | 559 | 0,2 | 0,15 | 15 | | | | | | |
| 14000 | 10500 | 7000 | 3500 | 602 | 0,2 | 0,17 | 17 | | | | | | |
| 15000 | 11250 | 7500 | 3750 | 645 | 0,2 | 0,19 | 19 | | | | | | |
| 16000 | 12000 | 8000 | 4000 | 688 | 0,2 | 0,22 | 22 | | | | | | |
| 17000 | 12750 | 8500 | 4250 | 731 | 0,2 | 0,24 | 24 | | | | | | |
| 18000 | 13500 | 9000 | 4500 | 775 | 0,3 | 0,26 | 26 | | | | | | |
| 19000 | 14250 | 9500 | 4750 | 818 | 0,3 | 0,29 | 29 | | | | | | |
| 20000 | 15000 | 10000 | 5000 | 861 | 0,3 | 0,32 | 32 | | | | | | |
| 22000 | 16500 | 11000 | 5500 | 947 | 0,3 | 0,38 | 38 | | | | | | |
| 24000 | 18000 | 12000 | 6000 | 1033 | 0,3 | 0,44 | 44 | | | | | | |
| 26000 | 19500 | 13000 | 6500 | 1119 | 0,4 | 0,50 | 50 | | | | | | |
| 28000 | 21000 | 14000 | 7000 | 1205 | 0,4 | 0,57 | 57 | | | | | | |
| 30000 | 22500 | 15000 | 7500 | 1291 | 0,4 | 0,65 | 65 | 0,3 | 0,21 | 21 | | | |
| 32000 | 24000 | 16000 | 8000 | 1377 | 0,5 | 0,72 | 72 | 0,3 | 0,23 | 23 | | | |
| 34000 | 25500 | 17000 | 8500 | 1463 | 0,5 | 0,80 | 80 | 0,3 | 0,26 | 26 | | | |
| 36000 | 27000 | 18000 | 9000 | 1549 | 0,5 | 0,89 | 89 | 0,3 | 0,28 | 28 | | | |
| 38000 | 28500 | 19000 | 9500 | 1635 | 0,5 | 0,98 | 98 | 0,3 | 0,31 | 31 | | | |
| 40000 | 30000 | 20000 | 10000 | 1721 | 0,6 | 1,07 | 107 | 0,4 | 0,34 | 34 | | | |
| 42000 | 31500 | 21000 | 10500 | 1807 | 0,6 | 1,16 | 116 | 0,4 | 0,37 | 37 | | | |
| 44000 | 33000 | 22000 | 11000 | 1893 | 0,6 | 1,26 | 126 | 0,4 | 0,40 | 40 | | | |
| 46000 | 34500 | 23000 | 11500 | 1979 | 0,7 | 1,36 | 136 | 0,4 | 0,43 | 43 | | | |
| 48000 | 36000 | 24000 | 12000 | 2065 | 0,7 | 1,47 | 147 | 0,4 | 0,47 | 47 | 0,3 | 0,12 | 12 |
| 50000 | 37500 | 25000 | 12500 | 2151 | 0,7 | 1,58 | 158 | 0,4 | 0,50 | 50 | 0,3 | 0,13 | 13 |
| 52000 | 39000 | 26000 | 13000 | 2238 | 0,7 | 1,69 | 169 | 0,5 | 0,54 | 54 | 0,3 | 0,14 | 14 |
| 54000 | 40500 | 27000 | 13500 | 2324 | 0,8 | 1,81 | 181 | 0,5 | 0,57 | 57 | 0,3 | 0,15 | 15 |
| 56000 | 42000 | 28000 | 14000 | 2410 | 0,8 | 1,93 | 193 | 0,5 | 0,61 | 61 | 0,3 | 0,16 | 16 |
| 58000 | 43500 | 29000 | 14500 | 2496 | 0,8 | 2,05 | 205 | 0,5 | 0,65 | 65 | 0,3 | 0,17 | 17 |
| 60000 | 45000 | 30000 | 15000 | 2582 | 0,9 | 2,17 | 217 | 0,5 | 0,69 | 69 | 0,3 | 0,18 | 18 |
| 62000 | 46500 | 31000 | 15500 | 2668 | 0,9 | 2,30 | 230 | 0,5 | 0,73 | 73 | 0,3 | 0,19 | 19 |
| 64000 | 48000 | 32000 | 16000 | 2754 | 0,9 | 2,43 | 243 | 0,6 | 0,77 | 77 | 0,3 | 0,21 | 21 |
| 66000 | 49500 | 33000 | 16500 | 2840 | 0,9 | 2,57 | 257 | 0,6 | 0,82 | 82 | 0,3 | 0,22 | 22 |
| 68000 | 51000 | 34000 | 17000 | 2926 | 1,0 | 2,71 | 271 | 0,6 | 0,86 | 86 | 0,4 | 0,23 | 23 |
| 70000 | 52500 | 35000 | 17500 | 3012 | 1,0 | 2,85 | 285 | 0,6 | 0,91 | 91 | 0,4 | 0,25 | 25 |
| 72000 | 54000 | 36000 | 18000 | 3098 | 1,0 | 2,99 | 299 | 0,6 | 0,95 | 95 | 0,4 | 0,26 | 26 |
| 76000 | 57000 | 38000 | 19000 | 3270 | | | | 0,7 | 1,05 | 105 | 0,4 | 0,29 | 29 |
| 80000 | 60000 | 40000 | 20000 | 3442 | | | | 0,7 | 1,14 | 114 | 0,4 | 0,32 | 32 |
| 84000 | 63000 | 42000 | 21000 | 3614 | | | | 0,7 | 1,25 | 125 | 0,4 | 0,36 | 36 |
| 88000 | 66000 | 44000 | 22000 | 3787 | | | | 0,7 | 1,35 | 135 | 0,5 | 0,39 | 39 |
| 92000 | 69000 | 46000 | 23000 | 3959 | | | | 0,7 | 1,46 | 146 | 0,5 | 0,43 | 43 |
| 96000 | 72000 | 48000 | 24000 | 4131 | | | | 0,7 | 1,57 | 157 | 0,5 | 0,47 | 47 |
| 100000 | 75000 | 50000 | 25000 | 4303 | | | | 0,9 | 1,69 | 169 | 0,5 | 0,51 | 51 |
| 104000 | 78000 | 52000 | 26000 | 4475 | | | | 0,9 | 1,80 | 180 | 0,5 | 0,55 | 55 |
| 108000 | 81000 | 54000 | 27000 | 4647 | | | | 0,9 | 1,93 | 193 | 0,6 | 0,59 | 59 |
| 112000 | 84000 | 56000 | 28000 | 4819 | | | | 1,0 | 2,06 | 206 | 0,6 | 0,64 | 64 |
| 116000 | 87000 | 58000 | 29000 | 4991 | | | | 1,0 | 2,19 | 219 | 0,6 | 0,68 | 68 |
| 120000 | 90000 | 60000 | 30000 | 5164 | | | | 1,1 | 2,32 | 232 | 0,6 | 0,73 | 73 |
| 126000 | 94500 | 63000 | 31500 | 5417 | | | | | | | 0,7 | 0,80 | 80 |
| 132000 | 99000 | 66000 | 33000 | 5675 | | | | | | | 0,7 | 0,88 | 88 |
| 138000 | 103500 | 69000 | 34500 | 5933 | | | | | | | 0,7 | 0,96 | 96 |
| 144000 | 108000 | 72000 | 36000 | 6191 | | | | | | | 0,8 | 1,05 | 105 |
| 150000 | 112500 | 75000 | 37500 | 6449 | | | | | | | 0,8 | 1,14 | 114 |
| 156000 | 117000 | 78000 | 39000 | 6707 | | | | | | | 0,8 | 1,23 | 123 |
| 162000 | 121500 | 81000 | 40500 | 6965 | | | | | | | 0,8 | 1,33 | 133 |
| 168000 | 126000 | 84000 | 42000 | 7223 | | | | | | | 0,9 | 1,43 | 143 |
| 174000 | 130500 | 87000 | 43500 | 7481 | | | | | | | 0,9 | 1,53 | 153 |
| 180000 | 135000 | 90000 | 45000 | 7739 | | | | | | | 0,9 | 1,64 | 164 |
| 186000 | 139500 | 93000 | 46500 | 7997 | | | | | | | 1,0 | 1,75 | 175 |
| 192000 | 144000 | 96000 | 48000 | 8255 | | | | | | | 1,0 | 1,86 | 186 |
| 198000 | 148500 | 99000 | 49500 | 8512 | | | | | | | 1,1 | 1,98 | 198 |
| 204000 | 153000 | 102000 | 51000 | 8770 | | | | | | | 1,1 | 2,10 | 210 |
| 210000 | 157500 | 105000 | 52500 | 9028 | | | | | | | 1,1 | 2,23 | 223 |
| 216000 | 162000 | 108000 | 54000 | 9286 | | | | | | | 1,1 | 2,36 | 236 |
| 222000 | 166500 | 111000 | 55500 | 9544 | | | | | | | 1,2 | 2,49 | 249 |
| 228000 | 171000 | 114000 | 57000 | 9802 | | | | | | | 1,2 | 2,63 | 263 |
| 234000 | 175500 | 117000 | 58500 | 10060 | | | | | | | 1,2 | 2,77 | 277 |
| 240000 | 180000 | 120000 | 60000 | 10318 | | | | | | | 1,3 | 2,91 | 291 |



Diagramms of the floorheating manifold

Adjustment of regulation valves

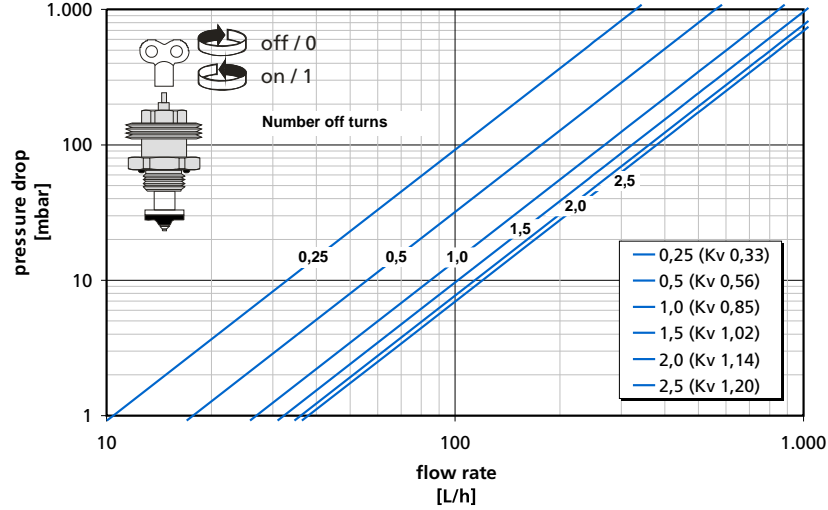

Total pressure drop

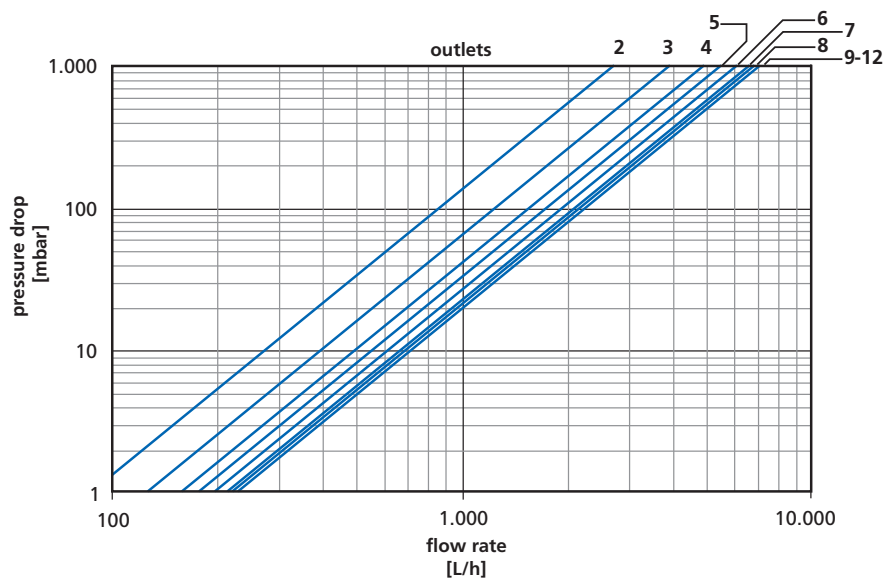

Pressure and temperature limits

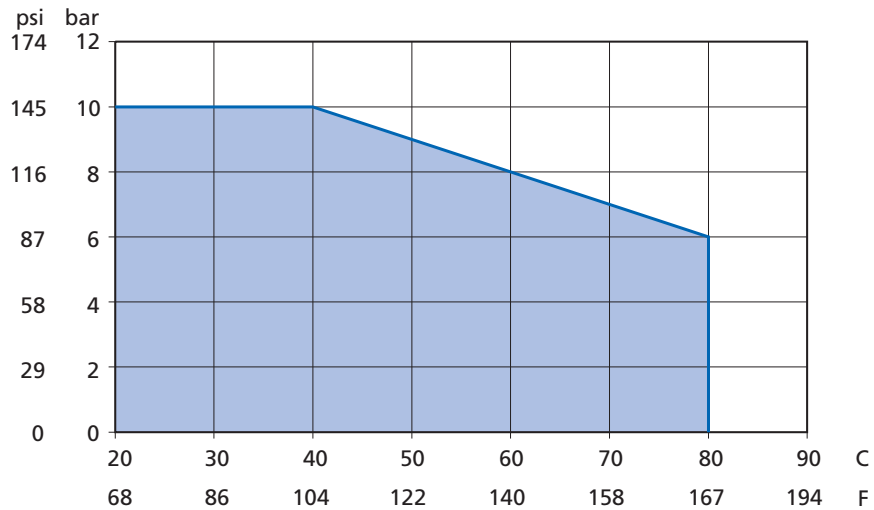









The parameters pressure and temperature must be within the limits shown.

Head losses in a fitting (coupler)

What is the separate resistance coefficient?

The resistance coefficient is defined by a test. Therefore, this is a purely empiric value that may differ significantly. The values stated in the following tables are the values, proven good at practice as a base for the calculation of head losses in the piping system.

Resistance coefficient values (depending on geometry):

| | | |
|---|---|-------------|
| Armature connector (long/short bend) |  | $\xi = 1,6$ |
| Reduction-bend with an inner or outer thread |  | $\xi = 1,6$ |
| Direction changes by bend |  | $\xi = 1,3$ |
| T-piece (stream dividing / distribution) |  | $\xi = 1,6$ |
| T-piece (passing) |  | $\xi = 0,3$ |
| T-piece (passage / counter-flowing stream distribution) |  | $\xi = 1,7$ |
| Reduction piece |  | $\xi = 0,6$ |
| Manifold output |  | $\xi = 1,6$ |

To calculate the total piping head loss, it is necessary to include all separated parts with a care. From the experience it is recommended recording various independent components into the table.

In the upper part there are now shown and summarized the coefficients of separated resistance losses. Using the summary and the equation stated below, it is now possible to calculate the total loss originating from the use of fittings.

To enumerate the total device head losses, the sum is added to the losses originated in piping and other used modules and components.

Total resistance coefficient

$$Z = \sum \xi \cdot w^2 \cdot 5$$

$$\Delta p_g = R \cdot l + Z + \Delta p_v$$

Z = sum of separated resistances [mbar]

w = medium flow rate [m/s]

ξ = loss factor (depending on geometry)

Δp_g = total loss in a heating circuit

R = head loss per m of pipe [Pa/m]

l = pipe length in m

Z = sum of separated resistances

Δp_v = head loss of e.g. thermostatic valve or heating circuit

More information

In case you need more technical information or consultation on the RADOPRESS system, contact our company salesmen or directly Service Centre on its e-mail address: radopress@pipelife.com.

PIPES

RADOPRESS UNIVERSAL PIPEING SYSTEM FOR RADIATOR HEATING AND HOT & COLD WATER

5 layers PEX-ALU-PEX pipes acc.to: EN ISO 21003-1
 2 PIPE APPLICATION CLASS 70 °C DESIGN TEMPERATURE, 10 BAR DESIGN PRESSURE
 4 PIPE APPLICATION CLASS 20-60 °C DESIGN TEMPERATURE, 10 BAR DESIGN PRESSURE
 5 PIPE APPLICATION CLASS 20-80 °C DESIGN TEMPERATURE, 10 BAR DESIGN PRESSURE



| | |
|------------|-----------------------------|
| RP16x2-200 | PEX-AL-PEX pipe 16x2mm/200m |
| RP18x2-200 | PEX-AL-PEX pipe 18x2mm/200m |
| RP20x2-100 | PEX-AL-PEX pipe 20x2mm/100m |
| RP26x3-100 | PEX-AL-PEX pipe 26x3mm/100m |
| RP32x3-50 | PEX-AL-PEX pipe 32x3mm/50m |

RADOPRESS UNIVERSAL PIPEING SYSTEM FOR RADIATOR HEATING AND HOT & COLD WATER

5 layers PE-RT-AL-PE-RT pipes acc.to: EN ISO 21003-1
 2 PIPE APPLICATION CLASS 70 °C DESIGN TEMPERATURE, 10 BAR DESIGN PRESSURE
 4 PIPE APPLICATION CLASS 20-60 °C DESIGN TEMPERATURE, 10 BAR DESIGN PRESSURE
 5 PIPE APPLICATION CLASS 20-80 °C DESIGN TEMPERATURE, 10 BAR DESIGN PRESSURE

| | |
|----------------|---------------------------------|
| RP16x2-200PERT | PE-RT-AL-PE-RT pipe 16x2mm/200m |
| RP18x2-200PERT | PE-RT-AL-PE-RT pipe 18x2mm/200m |
| RP20x2-100PERT | PE-RT-AL-PE-RT pipe 20x2mm/100m |
| RP26x3-100PERT | PE-RT-AL-PE-RT pipe 26x3mm/100m |
| RP32x3-50PERT | PE-RT-AL-PE-RT pipe 32x3mm/50m |



| | |
|------------|-----------------------------|
| RP16x2-5 | PEX-AL-PEX pipe 16x2mm/5m |
| RP18x2-5 | PEX-AL-PEX pipe 18x2mm/5m |
| RP20x2-5 | PEX-AL-PEX pipe 20x2mm/5m |
| RP26x3-5 | PEX-AL-PEX pipe 26x3mm/5m |
| RP32x3-5 | PEX-AL-PEX pipe 32x3mm/5m |
| RP40x3,5-5 | PEX-AL-PEX pipe 40x3,5mm/5m |
| RP50x4-5 | PEX-AL-PEX pipe 50x4mm/5m |
| RP63x4,5-5 | PEX-AL-PEX pipe 63x4,5mm/5m |

| | |
|--------------|-------------------------------|
| RP16x2-5PERT | PE-RT-AL-PE-RT pipe 16x2mm/5m |
| RP18x2-5PERT | PE-RT-AL-PE-RT pipe 18x2mm/5m |
| RP20x2-5PERT | PE-RT-AL-PE-RT pipe 20x2mm/5m |
| RP26x3-5PERT | PE-RT-AL-PE-RT pipe 26x3mm/5m |
| RP32x3-5PERT | PE-RT-AL-PE-RT pipe 32x3mm/5m |

PRE-INSULATED PEX-AL-PEX PIPE



| | |
|--------------------|--|
| RP16x2-100-I-B/B.M | PEX-AL-PEX pipe 16/12mm/200m isolated blue |
| RP16x2-100-I-R/B.M | PEX-AL-PEX pipe 16/12mm/200m isolated red |
| RP20x2-100-I-B/B.M | PEX-AL-PEX pipe 20/16mm/100m isolated blue |
| RP20x2-100-I-R/B.M | PEX-AL-PEX pipe 20/16mm/100m isolated red |

PROTECTION PIPE



| | |
|----------------|--|
| RP-PROT16-50R | Corrugated protection pipe for 16x2 pipe red |
| RP-PROT16-50B | Corrugated protection pipe for 16x2 pipe blue |
| RP-PROT16-50BK | Corrugated protection pipe for 16x2 pipe black |
| RP-PROT20-50R | Corrugated protection pipe for 20x2 pipe red |
| RP-PROT20-50B | Corrugated protection pipe for 20x2 pipe blue |
| RP-PROT20-50BK | Corrugated protection pipe for 20x2 pipe black |
| RP-PROT26-50R | Corrugated protection pipe for 26x2 pipe red |
| RP-PROT26-50B | Corrugated protection pipe for 26x2 pipe blue |
| RP-PROT26-50BK | Corrugated protection pipe for 26x2 pipe black |

PIPE PE-RT EVOH FOR DISTRIBUTION OF FLOOR HEATING



| | |
|----------|---------------|
| FT-R18L3 | 18X2-roll300m |
| FT-R18L4 | 18X2-roll400m |

PRESS FITTINGS

BRASS COUPLING



| | |
|--------|----|
| RP-M16 | 16 |
| RP-M18 | 18 |
| RP-M20 | 20 |
| RP-M26 | 26 |
| RP-M32 | 32 |
| RP-M40 | 40 |
| RP-M50 | 50 |
| RP-M63 | 63 |

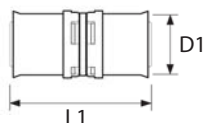

| D1 | D2 | D3 | L1 | L2 |
|--------|----|----|------|----|
| 16x2 | - | - | 57 | - |
| 18x2 | - | - | 65 | - |
| 20x2 | - | - | 57,7 | - |
| 26x3 | - | - | 65 | - |
| 32x3 | - | - | 65 | - |
| 40x3,5 | - | - | 65 | - |
| 50x4 | - | - | 97 | - |
| 63x4,5 | - | - | 98 | - |

PPSU COUPLING



| | |
|-------------|----|
| PUM-016KARM | 16 |
| PUM-020KARM | 20 |
| PUM-026KARM | 26 |
| PUM-032KARM | 32 |

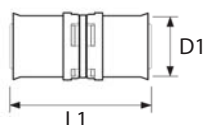

| D1 | D2 | D3 | L1 | L2 |
|------|----|----|----|----|
| 16x2 | - | - | 50 | - |
| 20x2 | - | - | 56 | - |
| 26x3 | - | - | 66 | - |
| 32x3 | - | - | 76 | - |

REDUCED BRASS COUPLING



| | |
|-----------|---------|
| RP-R18/16 | 18 / 16 |
| RP-R20/16 | 20 / 16 |
| RP-R20/18 | 20 / 18 |
| RP-R26/16 | 26 / 16 |
| RP-R26/18 | 26 / 18 |
| RP-R26/20 | 26 / 20 |
| RP-R32/16 | 32 / 16 |
| RP-R32/18 | 32 / 18 |
| RP-R32/20 | 32 / 20 |
| RP-R32/26 | 32 / 26 |
| RP-R40/26 | 40 / 26 |
| RP-R40/32 | 40 / 32 |
| RP-R50/26 | 50 / 26 |
| RP-R50/32 | 50 / 32 |
| RP-R50/40 | 50 / 40 |
| RP-R63/26 | 63 / 26 |
| RP-R63/32 | 63 / 32 |
| RP-R63/40 | 63 / 40 |
| RP-R63/50 | 63 / 50 |

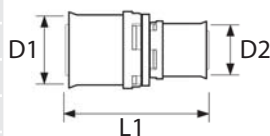

| D1 | D2 | D3 | L1 | L2 |
|--------|--------|----|------|----|
| 18x2 | 16x2 | - | 65 | - |
| 20x2 | 16x2 | - | 61,7 | - |
| 20x2 | 18x2 | - | 65 | - |
| 26x3 | 16x2 | - | 65 | - |
| 26x3 | 18x2 | - | 65 | - |
| 26x3 | 20x2 | - | 65 | - |
| 32x3 | 16x2 | - | 65 | - |
| 32x3 | 18x2 | - | 65 | - |
| 32x3 | 20x2 | - | 65 | - |
| 32x3 | 26x3 | - | 65 | - |
| 40x3,5 | 26x3 | - | 65 | - |
| 40x3,5 | 32x3 | - | 65 | - |
| 50x4 | 26x3 | - | 81 | - |
| 50x4 | 32x3 | - | 81 | - |
| 50x4 | 40x3,5 | - | 81 | - |
| 63x4,5 | 26x3 | - | 81,5 | - |
| 63x4,5 | 32x3 | - | 81,5 | - |
| 63x4,5 | 40x3,5 | - | 81,5 | - |
| 63x4,5 | 50x4 | - | 97,5 | - |

REDUCED COUPLING - PPSU



| | |
|-------------|---------|
| PUR-20 / 16 | 20 / 16 |
| PUR-26 / 20 | 26 / 20 |
| PUR-32 / 26 | 32 / 26 |

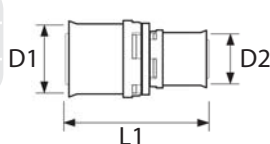

| D1 | D2 | D3 | L1 | L2 |
|------|------|----|----|----|
| 20x3 | 16x2 | - | 53 | - |
| 26x3 | 20x2 | - | 61 | - |
| 32x3 | 26x3 | - | 71 | - |

ELBOW 90° - BRASS



| | |
|-----------|----|
| RP-W16/90 | 16 |
| RP-W18/90 | 18 |
| RP-W20/90 | 20 |
| RP-W26/90 | 26 |
| RP-W32/90 | 32 |
| RP-W40/90 | 40 |
| RP-W50/90 | 50 |
| RP-W63/90 | 63 |

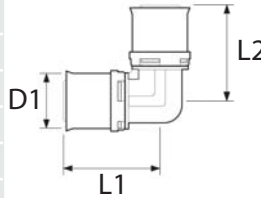

| D1 | D2 | D3 | L1 | L2 |
|--------|----|----|------|------|
| 16x2 | - | - | 38,5 | 38,5 |
| 18x2 | - | - | 41,5 | 41,5 |
| 20x2 | - | - | 41,5 | 41,5 |
| 26x3 | - | - | 48,5 | 48,5 |
| 32x3 | - | - | 53 | 53 |
| 40x3,5 | - | - | 55 | 55 |
| 50x4 | - | - | 76 | 76 |
| 63x4,5 | - | - | 83 | 83 |

ELBOW 90° - PPSU



| | |
|----------------|----|
| PUW016KONYOK90 | 16 |
| PUW020KONYOK90 | 20 |
| PUW026KONYOK90 | 26 |
| PUW032KONYOK90 | 32 |

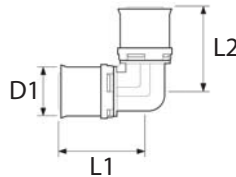

| D1 | D2 | D3 | L1 | L2 |
|------|----|----|----|----|
| 16x2 | - | - | 38 | 38 |
| 20x2 | - | - | 43 | 43 |
| 26x3 | - | - | 53 | 53 |
| 32x3 | - | - | 60 | 60 |

ELBOW 45° - BRASS



| | |
|-----------|----|
| RP-W32/45 | 32 |
| RP-W40/45 | 40 |
| RP-W50/45 | 50 |
| RP-W63/45 | 63 |

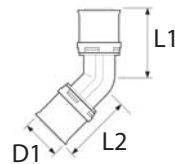

| D1 | D2 | D3 | L1 | L2 |
|--------|----|----|------|------|
| 32x3 | - | - | 58 | 58 |
| 40x3,5 | - | - | 55,5 | 55,5 |
| 50x4 | - | - | 76 | 76 |
| 63x4,5 | - | - | 83 | 83 |

ELBOW 45° - PPSU



| | |
|------------|----|
| PUW026IV45 | 26 |
| PUW032IV45 | 32 |

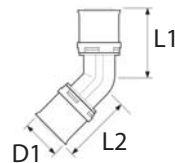

| D1 | D2 | D3 | L1 | L2 |
|------|----|----|----|----|
| 26x2 | - | - | 51 | 51 |
| 32x3 | - | - | 56 | 56 |

T-PIECE - BRASS



| | |
|--------|----|
| RP-T16 | 16 |
| RP-T18 | 18 |
| RP-T20 | 20 |
| RP-T26 | 26 |
| RP-T32 | 32 |
| RP-T40 | 40 |
| RP-T50 | 50 |
| RP-T63 | 63 |

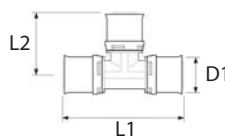

| D1 | D2 | D3 | L1 | L2 |
|--------|----|----|-----|------|
| 16x2 | - | - | 77 | 38,5 |
| 18x2 | - | - | 83 | 41,5 |
| 20x2 | - | - | 83 | 41,5 |
| 26x3 | - | - | 102 | 51 |
| 32x3 | - | - | 106 | 53 |
| 40x3,5 | - | - | 110 | 55 |
| 50x4 | - | - | 152 | 76 |
| 63x4,5 | - | - | 166 | 83 |

T-PIECE - PPSU



| | |
|------------------|----|
| PUT16X16X16TIDOM | 16 |
| PUT20X20X20TIDOM | 20 |
| PUT26X26X26TIDOM | 26 |
| PUT32X32X32TIDOM | 32 |

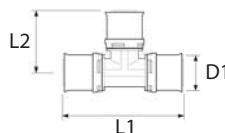

| D1 | D2 | D3 | L1 | L2 |
|------|----|----|-----|----|
| 16x2 | - | - | 80 | 40 |
| 20x2 | - | - | 86 | 43 |
| 26x3 | - | - | 110 | 55 |
| 32x3 | - | - | 120 | 60 |

DRINKING AND SANITARY HOT WATER, CENTRAL HEATING AND FLOOR HEATING

T-PIECE - REDUCED - BRASS

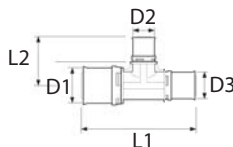

| | |
|--------------|--------------|
| RP-T16/18/16 | 16 x 18 x 16 |
| RP-T16/20/16 | 16 x 20 x 16 |
| RP-T18/16/16 | 18 x 16 x 16 |
| RP-T18/16/18 | 18 x 16 x 18 |
| RP-T20/16/16 | 20 x 16 x 16 |
| RP-T20/16/18 | 20 x 16 x 18 |
| RP-T20/16/20 | 20 x 16 x 20 |
| RP-T20/18/18 | 20 x 18 x 18 |
| RP-T20/18/20 | 20 x 18 x 20 |
| RP-T20/20/16 | 20 x 20 x 16 |
| RP-T20/26/20 | 20 x 26 x 20 |
| RP-T26/16/20 | 26 x 16 x 20 |
| RP-T26/16/26 | 26 x 16 x 26 |
| RP-T26/18/18 | 26 x 18 x 18 |
| RP-T26/18/26 | 26 x 18 x 26 |
| RP-T26/20/16 | 26 x 20 x 16 |
| RP-T26/20/20 | 26 x 20 x 20 |
| RP-T26/20/26 | 26 x 20 x 26 |
| RP-T26/26/16 | 26 x 26 x 16 |
| RP-T26/26/20 | 26 x 26 x 20 |
| RP-T32/16/32 | 32 x 16 x 32 |
| RP-T32/18/32 | 32 x 18 x 32 |
| RP-T32/20/26 | 32 x 20 x 26 |
| RP-T32/20/32 | 32 x 20 x 32 |
| RP-T32/26/26 | 32 x 26 x 26 |
| RP-T32/26/32 | 32 x 26 x 32 |
| RP-T32/32/26 | 32 x 32 x 26 |
| RP-T40/26/32 | 40 x 26 x 32 |
| RP-T40/26/40 | 40 x 26 x 40 |
| RP-T40/32/32 | 40 x 32 x 32 |
| RP-T40/32/40 | 40 x 32 x 40 |
| RP-T40/40/26 | 40 x 40 x 26 |
| RP-T40/40/32 | 40 x 40 x 32 |
| RP-T50/26/50 | 50 x 26 x 50 |
| RP-T50/32/50 | 50 x 32 x 50 |
| RP-T50/40/40 | 50 x 40 x 40 |
| RP-T50/40/50 | 50 x 40 x 50 |
| RP-T50/50/32 | 50 x 50 x 32 |
| RP-T50/50/40 | 50 x 50 x 40 |
| RP-T63/40/63 | 63 x 40 x 63 |
| RP-T63/50/63 | 63 x 50 x 63 |

| D1 | D2 | D3 | L1 | L2 |
|--------|--------|--------|-----|------|
| 16x2 | 18x2 | 16x2 | 88 | 44 |
| 16x2 | 20x2 | 16x2 | 83 | 41,5 |
| 18x2 | 16x2 | 16x2 | 88 | 44 |
| 18x2 | 16x2 | 18x2 | 88 | 44 |
| 20x2 | 16x2 | 16x2 | 83 | 41,5 |
| 20x2 | 16x2 | 18x2 | 88 | 44 |
| 20x2 | 16x2 | 20x2 | 83 | 41,5 |
| 20x2 | 18x2 | 18x2 | 88 | 44 |
| 20x2 | 18x2 | 20x2 | 88 | 44 |
| 20x2 | 20x2 | 16x2 | 83 | 41,5 |
| 20x2 | 26x3 | 20x2 | 102 | 51 |
| 26x3 | 16x2 | 20x2 | 97 | 51 |
| 26x3 | 16x2 | 26x3 | 97 | 48,5 |
| 26x3 | 18x2 | 18x2 | 102 | 51 |
| 26x3 | 18x2 | 26x3 | 102 | 51 |
| 26x3 | 20x2 | 16x2 | 102 | 51 |
| 26x3 | 20x2 | 20x2 | 102 | 51 |
| 26x3 | 20x2 | 26x3 | 97 | 48,5 |
| 26x3 | 26x3 | 16x2 | 112 | 56 |
| 26x3 | 26x3 | 20x2 | 112 | 56 |
| 32x3 | 16x2 | 32x3 | 106 | 53 |
| 32x3 | 18x2 | 32x3 | 106 | 53 |
| 32x3 | 20x2 | 26x3 | 106 | 53 |
| 32x3 | 20x2 | 32x3 | 106 | 53 |
| 32x3 | 26x3 | 26x3 | 106 | 53 |
| 32x3 | 26x3 | 32x3 | 106 | 53 |
| 32x3 | 32x3 | 26x3 | 106 | 53 |
| 40x3,5 | 26x3 | 32x3 | 110 | 55 |
| 40x3,5 | 26x3 | 40x3,5 | 110 | 55 |
| 40x3,5 | 32x3 | 32x3 | 110 | 50 |
| 40x3,5 | 32x3 | 40x3,5 | 110 | 55 |
| 40x3,5 | 40x3,5 | 26x3 | 110 | 55 |
| 40x3,5 | 40x3,5 | 32x3 | 110 | 55 |
| 50x4 | 26x3 | 50x4 | 152 | 62 |
| 50x4 | 32x3 | 50x4 | 152 | 62 |
| 50x4 | 40x3,5 | 50x4 | 152 | 61 |
| 50x4 | 40x3,5 | 40x3,5 | 152 | 62 |
| 50x4 | 50x4 | 32x3 | 152 | 76 |
| 50x4 | 50x4 | 40x3,5 | 152 | 76 |
| 63x4,5 | 40x3,5 | 63x4,5 | 153 | 70 |
| 63x4,5 | 50x4 | 63x4,5 | 166 | 82,5 |

T-PIECE - REDUCED - PPSU



| | |
|------------------|--------------|
| PUT16X20X16TIDOM | 16 x 20 x 16 |
| PUT20X16X16TIDOM | 20 x 16 x 16 |
| PUT20X16X20TIDOM | 20 x 16 x 20 |
| PUT20X20X16TIDOM | 20 x 20 x 16 |
| PUT20X26X20TIDOM | 20 x 26 x 20 |
| PUT20X32X20TIDOM | 20 x 32 x 20 |
| PUT26X16X20TIDOM | 26 x 16 x 20 |
| PUT26X16X26TIDOM | 26 x 16 x 26 |
| PUT26X20X16TIDOM | 26 x 20 x 16 |
| PUT26X20X20TIDOM | 26 x 20 x 20 |
| PUT26X20X26TIDOM | 26 x 20 x 26 |
| PUT26X26X16TIDOM | 26 x 26 x 16 |
| PUT26X26X20TIDOM | 26 x 26 x 20 |
| PUT26X32X20TIDOM | 26 x 32 x 20 |
| PUT26X32X26TIDOM | 26 x 32 x 26 |
| PUT32X16X32TIDOM | 32 x 16 x 32 |
| PUT32X20X20TIDOM | 32 x 20 x 20 |
| PUT32X20X26TIDOM | 32 x 20 x 26 |
| PUT32X20X32TIDOM | 32 x 20 x 32 |
| PUT32X26X20TIDOM | 32 x 26 x 20 |
| PUT32X26X26TIDOM | 32 x 26 x 26 |
| PUT32X26X32TIDOM | 32 x 26 x 32 |
| PUT32X32X20TIDOM | 32 x 32 x 20 |
| PUT32X32X26TIDOM | 32 x 32 x 26 |

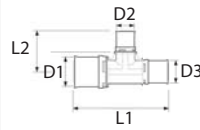

| D1 | D2 | D3 | L1 | L2 |
|------|------|------|-----|----|
| 16x2 | 20x2 | 16x2 | 80 | 41 |
| 20x2 | 16x2 | 16x2 | 79 | 40 |
| 20x2 | 16x2 | 20x2 | 82 | 40 |
| 20x2 | 20x2 | 16x2 | 83 | 43 |
| 20x2 | 26x3 | 20x2 | 96 | 50 |
| 20x2 | 32x3 | 20x2 | 100 | 54 |
| 26x3 | 16x2 | 20x2 | 89 | 44 |
| 26x3 | 16x2 | 26x3 | 94 | 45 |
| 26x3 | 20x2 | 16x2 | 92 | 48 |
| 26x3 | 20x2 | 20x2 | 95 | 48 |
| 26x3 | 20x2 | 26x3 | 100 | 48 |
| 26x3 | 26x3 | 16x2 | 98 | 53 |
| 26x3 | 26x3 | 20x2 | 101 | 53 |
| 26x3 | 32x3 | 20x2 | 105 | 57 |
| 26x3 | 32x3 | 26x3 | 110 | 57 |
| 32x3 | 16x2 | 32x3 | 104 | 47 |
| 32x3 | 20x2 | 20x2 | 98 | 50 |
| 32x3 | 20x2 | 26x3 | 103 | 50 |
| 32x3 | 20x2 | 32x3 | 108 | 50 |
| 32x3 | 26x3 | 20x2 | 104 | 55 |
| 32x3 | 26x3 | 26x3 | 109 | 55 |
| 32x3 | 26x3 | 32x3 | 114 | 55 |
| 32x3 | 32x3 | 20x2 | 110 | 60 |
| 32x3 | 32x3 | 26x3 | 115 | 60 |

PLUG - BRASS



| | |
|----------|----|
| RP-END16 | 16 |
| RP-END18 | 20 |
| RP-END20 | 26 |
| RP-END50 | 50 |

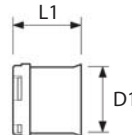

| D1 | D2 | D3 | L1 | L2 |
|------|----|----|-------|----|
| 16x2 | - | - | 30,85 | - |
| 18x2 | - | - | 32,5 | - |
| 20x2 | - | - | 30,85 | - |
| 50x4 | - | - | 48,5 | - |

PLUG - PPSU



| | |
|------------------|----|
| PUK-VÉGELZÁRO016 | 16 |
| PUK-VÉGELZÁRO020 | 20 |
| PUK-VÉGELZÁRO026 | 26 |
| PUK-VÉGELZÁRO032 | 32 |

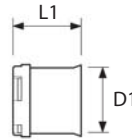

| D1 | D2 | D3 | L1 | L2 |
|------|----|----|----|----|
| 16x2 | - | - | 21 | - |
| 20x2 | - | - | 24 | - |
| 26x3 | - | - | 28 | - |
| 32x3 | - | - | 32 | - |

DRINKING AND SANITARY HOT WATER, CENTRAL HEATING AND FLOOR HEATING

COUPLING WITH MALE THREAD



| | |
|--------------|-----------|
| RP-UAG16/1/2 | 16 x 1/2" |
| RP-UAG18/1/2 | 18 x 1/2" |
| RP-UAG18/3/4 | 18 x 3/4" |
| RP-UAG20/1/2 | 20 x 1/2" |
| RP-UAG20/3/4 | 20 x 3/4" |
| RP-UAG26/1 | 26 x 1" |
| RP-UAG26/3/4 | 26 x 3/4" |
| RP-UAG32/1 | 32 x 1" |
| RP-UAG32/5/4 | 32 x 5/4" |
| RP-UAG40/1 | 40 x 1" |
| RP-UAG40/5/4 | 40 x 5/4" |
| RP-UAG50/6/4 | 50 x 6/4" |
| RP-UAG63/2 | 63 x 2" |

COUPLING WITH FEMALE THREAD



| | |
|--------------|-----------|
| RP-UIG16/1/2 | 16 x 1/2" |
| RP-UIG18/1/2 | 18 x 1/2" |
| RP-UIG20/1/2 | 20 x 1/2" |
| RP-UIG20/3/4 | 20 x 3/4" |
| RP-UIG26/1 | 26 x 1" |
| RP-UIG26/3/4 | 26 x 3/4" |
| RP-UIG32/1 | 32 x 1" |
| RP-UIG32/5/4 | 32 x 5/4" |
| RP-UIG40/1 | 40 x 1" |
| RP-UIG40/5/4 | 40 x 5/4" |
| RP-UIG50/6/4 | 50 x 6/4" |
| RP-UIG63/2 | 63 x 2" |

ELBOW 90° WITH MALE THREAD



| | |
|--------------|-----------|
| RP-UWA16/1/2 | 16 x 1/2" |
| RP-UWA18/1/2 | 18 x 1/2" |
| RP-UWA20/1/2 | 20 x 1/2" |
| RP-UWA20/3/4 | 20 x 3/4" |
| RP-UWA26/3/4 | 26 x 3/4" |
| RP-UWA32/1 | 32 x 1" |
| RP-UWA40/5/4 | 40 x 5/4" |

ELBOW 90° WITH FEMALE THREAD



| | |
|---------------|-----------|
| RP-UPWI16/3/4 | 16 X 3/4" |
| RP-UPWI18/3/4 | 18 X 3/4" |
| RP-UPWI20/3/4 | 20 X 3/4" |

ELBOW 90° WITH FEMALE THREAD



| | |
|--------------|-----------|
| RP-UWI16/1/2 | 16 x 1/2" |
| RP-UWI18/1/2 | 18 x 1/2" |
| RP-UWI20/1/2 | 20 x 1/2" |
| RP-UWI20/3/4 | 20 x 3/4" |
| RP-UWI26/3/4 | 26 x 3/4" |
| RP-UWI32/1 | 32 x 1" |
| RP-UWI40/5/4 | 40 x 5/4" |

T-PIECE WITH MALE THREAD



| | |
|-------------|-----------|
| RP-TA16/1/2 | 16 x 1/2" |
| RP-TA18/1/2 | 18 x 1/2" |
| RP-TA20/1/2 | 20 x 1/2" |
| RP-TA20/3/4 | 20 x 3/4" |
| RP-TA26/1 | 26 x 1" |
| RP-TA26/1/2 | 26 x 1/2" |
| RP-TA26/3/4 | 26 x 3/4" |
| RP-TA32/1 | 32 x 1" |
| RP-TA32/3/4 | 32 x 3/4" |
| RP-TA40/5/4 | 40 x 5/4" |
| RP-TA50/5/4 | 50 x 5/4" |
| RP-TA63/2 | 63 x 2" |

PRESSURE TEST SCEW PLUG (red and blue)



| | |
|---------------------|-----------|
| PPVAKDUGÓ 1/2" PNYI | 1/2" Red |
| PPVAKDUGÓ 1/2" KNYI | 1/2" Blue |



INHOUSE SYSTEM

T-PIECE WITH FEMALE THREAD



| | |
|-------------|-----------|
| RP-TI16/1/2 | 16 x 1/2" |
| RP-TI18/1/2 | 18 x 1/2" |
| RP-TI20/1/2 | 20 x 1/2" |
| RP-TI20/3/4 | 20 x 3/4" |
| RP-TI26/1/2 | 26 x 1/2" |
| RP-TI26/3/4 | 26 x 3/4" |
| RP-TI32/1 | 32 x 1" |
| RP-TI32/1/2 | 32 x 1/2" |
| RP-TI32/3/4 | 32 x 3/4" |
| RP-TI32/5/4 | 32 x 5/4" |
| RP-TI40/1 | 40 x 1" |
| RP-TI40/5/4 | 40 x 5/4" |
| RP-TI50/5/4 | 50 x 5/4" |
| RP-TI50/6/4 | 50 x 6/4" |
| RP-TI63/2 | 63 x 2" |

COUPLING WITH SLEEVE NUT



| | |
|--------------|-----------|
| RP-upv16/3/4 | 16 x 3/4" |
| RP-UPV16/1 | 16 x 1" |
| RP-UPV20/3/4 | 20 x 3/4" |
| RP-UPV20/1 | 20 x 1" |
| RP-UPV26/1 | 26 x 1" |
| RP-UPV26/5/4 | 26 x 5/4" |
| RP-UPV32/5/4 | 32 x 5/4" |
| RP-UPV32/6/4 | 32 x 6/4" |
| RP-UPV40/5/4 | 40 x 5/4" |
| RP-UPV40/6/4 | 40 x 6/4" |
| RP-UPV40/2 | 40 x 2" |
| RP-UPV50/6/4 | 50 x 6/4" |
| RP-UPV50/2 | 50 x 2" |

Sealing included.

DEMOUNTABLE CONNECTION



| | |
|---------|-----------|
| RP-VK16 | 16 x 3/4" |
| RP-VK20 | 20 x 3/4" |
| RP-VK26 | 26 x 1" |
| RP-VK32 | 32 x 5/4" |
| RP-VK40 | 40 x 5/4" |
| RP-VK50 | 50 x 6/4" |

DOUBLE WALL PIECE U



| | |
|--------------|----------------|
| RP-AAD16/16U | 16 - 16 x 1/2" |
| RP-AAD20/20U | 20 - 20 x 1/2" |

DOUBLE WALL PIECE



| | |
|-------------|--|
| RP-AAD16/16 | |
| RP-AAD20/20 | |

EXTENDED WALL PIECE



| | |
|-----------------|-------------------|
| RP-AAE16/1/2/80 | 16 x 1/2" - 80 mm |
| RP-AAE18/1/2/80 | 18 x 1/2" - 80 mm |
| RP-AAE20/1/2/80 | 20 x 1/2" - 80 mm |

WALL PIECE



| | |
|--------------|-----------|
| RP-AAE16/1/2 | 16 x 1/2" |
| RP-AAE18/1/2 | 18 x 1/2" |
| RP-AAE20/1/2 | 20 x 1/2" |
| RP-AAE20/3/4 | 20 x 3/4" |
| RP-AAE26/3/4 | 26 x 3/4" |

ASSEMBLY STRAP UNDER SPIGOT



| | |
|-------------|------------------|
| SI-DHE | 1 hole |
| SI-DH100 | 2 holes 100mm |
| SI-DH80/153 | 2 hole 80/153 mm |

DRINKING AND SANITARY HOT WATER, CENTRAL HEATING AND FLOOR HEATING

ASSEMBLY STRAP UNDER SLIGOT, FLEXIBLE



SI-DHB
For wall plates with 100 and 153mm distance
6pcs fixing screws included.

PRE ASSEMBLED WALL PIECE



RP-WALP16/1/2 16 x 1/2"
3 positions: middle
100mm
153mm

WALL PIECE RETAINING NUTS



RP-WDF16/1/2 16 x 1/2"
RP-WDF20/1/2 20 x 1/2"

ANTI-NOISE COVER



RP-SSE1 short 1/2"
RP-SSE4 short 3/4"
RP-SSE3 long 1/2"
RP-SSE2 double U

FLOOR REDUCTION - BEND



RP-SP16
RP-SP18

FLOOR REDUCTION - T-PIECE



RP-SP16/16
RP-SP20/20

BALL VALVE - LONG LEVER TYPE



RP-BVL16
RP-BVL20
RP-BVL26

BUILT IN VALVE



RP-WTV16 16 x 2,0
RP-WTV20 20 x 2,0
RP-WTV26 26 x 3,0

CONNECTING BOX



RP-BOX16/230 16 x 2,0

CONNECTING BEND TO RADIATOR



RP-HKW16/300 16 / 300 mm
RP-HKW18/300 18 / 300 mm
RP-HKW20/300 20 / 300 mm
RP-HKW16/1100 16 / 1100 mm
RP-HKW18/1100 18 / 1100 mm
RP-HKW20/1100 20 / 1100 mm

CONNECTING T-PIECE TO RADIATOR



RP-HKT16/300 16 / 300 mm
RP-HKT18/300 18 / 300 mm
RP-HKT20/300 20 / 300 mm
RP-HKT16/1100 16 / 1100 mm
RP-HKT18/1100 18 / 1100 mm
RP-HKT20/1100 20 / 1100 mm

PLINTH CONNECTION TO RADIATOR



RP-SO16 16/1/2"
RP-SO20 20/1/2"

CONNECTION BEND FOR PLINTH CONNECTION



RP-SO15

Cone screwing connection on fitting side.

CONNECTION BEND FOR PLINTH CONNECTION



RP-WA15

Cone screwing connection on fitting side, with built in lockshield valve.

CONNECTION ACCESSORIES FOR RADIATOR VALVES



RP-SCMI-15/1/2 Ø15 copper pipe – 1/2" eurocones

RP-SCMI-16/1/2 Ø16 PEX-AL-PEX pipe - 1/2" eurocones

RP-SCMI-15/3/4 Ø15 copper pipe – 3/4" eurocones

RP-SCMI-16/3/4 Ø16 PEX-AL-PEX pipe -3/4" eurocones

COVER PLATE



RA-ROSETTE

Simple white, consists of two parts.

RA-DUOROS50

Double white, consists of two parts with 50mm distance.

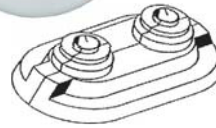

PRESS CONNECTION FITTING



RP-MCU16-15 Ø16 Radopress - Ø15 copper

RP-MCU16-18 Ø16 Radopress - Ø18 copper

RP-MCU18-15 Ø18 Radopress - Ø15 copper

RP-MCU20-15 Ø20 Radopress - Ø15 copper

RP-MCU20-18 Ø20 Radopress - Ø18 copper

RP-MCU20-22 Ø20 Radopress - Ø22 copper

RP-MCU26-22 Ø26 Radopress - Ø22 copper

RP-MCU26-28 Ø26 Radopress - Ø28 copper

NON CROSIN T-PIECE



RP-NOCT-16

16

INSULATION FOR NON CROSSING T-PIECE



RP-INOCT-16

16

PRESSING RING



RP-PH16

16

RP-PH18

18

RP-PH20

20

RP-PH26

26

RP-PH32

32

RP-PH40

40

RP-PH50

50

RP-PH63

63

SPARE O-RING FOR BRASS FITTINGS



RP-O16

16

RP-O18

18

RP-O20

20

RP-O26

26

RP-O32

32

RP-O40

40

RP-O50

50

RP-O63

63

RADIATOR VALVES

THERMOSTAT ADAPTABLE RADIATOR VALVES WITH HANDWHEEL



| | |
|---------|-----------------------|
| RP-RAVS | Straight, 1/2" - 1/2" |
| RP-RAVA | Corner, 1/2" - 1/2" |

THERMOSTATIC ACTUATOR HEAD



| | |
|----------|---|
| RP-THEAD | Thermostatic actuator head with liquid filled sensor. |
|----------|---|

THERMOSTATIC HEAD LOCK



| | |
|--------------|--|
| RP-THEADLOCK | Applicable with RP-THEAD It can fix the adjusted position of the thermo head. |
|--------------|--|

NICKEL PLATED LOCKSHIELD VALVE



| | |
|--------|-----------------------|
| RP-LVS | Straight, 1/2" - 1/2" |
| RP-LSA | Corner, 1/2" - 1/2" |

DOUBLE BLOCK RADIATOR VALVE WITHOUT BYPASS



| | |
|---------|----------------------------------|
| RP-DRVS | Straight, 3/4" - 3/4" eurocones. |
| RP-DRVA | Corner, 3/4" - 3/4" eurocones. |



SCREWING



| | |
|----------------|---------------------------------------|
| RP-SCMI-15/1/2 | Ø15 copper pipe - 1/2" eurocones. |
| RP-SCMI-16/1/2 | Ø16 PEX-AL-PEX pipe - 1/2" eurocones. |
| RP-SCMI-15/3/4 | Ø15 copper pipe - 3/4" eurocones. |
| RP-SCMI-16/3/4 | Ø16 PEX-AL-PEX pipe - 3/4" eurocones. |

REDUCER SCREW FOR DOUBLE BLOCK RADIATOR VALVE



| | |
|-----------|----------------------------------|
| RP-DRVNIP | 1/2" - 3/8" reducer with O-ring. |
|-----------|----------------------------------|

AIR VENT VALVES



| | |
|------------|-------------------------------|
| RP-AVE1/2 | Manual, 1/2" outer thread. |
| RP-AVEM3/8 | Automatic, 3/8" outer thread. |

END CAP FOR RADIATORS



| | |
|------------|--|
| RP-BP1/2OR | |
|------------|--|

MAINIFOLDS AND COLLECTORS

MANIFOLD FOR SANITARY DISTRIBUTIONS



| | |
|----------|------------|
| RP-SANV2 | 2 circuits |
| RP-SANV3 | 3 circuits |
| RP-SANV4 | 4 circuits |
| RP-SANV5 | 5 circuits |
| RP-SANV6 | 6 circuits |

Without accessories.
55mm distance.

MANIFOLD AND COLLECTOR FOR CENTRAL HEATING



| | |
|----------|-------------|
| RP-HKV2 | 2 circuits |
| RP-HKV3 | 3 circuits |
| RP-HKV4 | 4 circuits |
| RP-HKV5 | 5 circuits |
| RP-HKV6 | 6 circuits |
| RP-HKV7 | 7 circuits |
| RP-HKV8 | 8 circuits |
| RP-HKV9 | 9 circuits |
| RP-HKV10 | 10 circuits |

With air separator, sealing and fixing accessories.
55mm distance.

MANIFOLD AND COLLECTOR FOR FLOOR HEATING

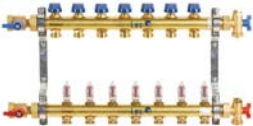

| | |
|---------|-------------|
| FT-V2A | 2 circuits |
| FT-V3A | 3 circuits |
| FT-V4A | 4 circuits |
| FT-V5A | 5 circuits |
| FT-V6A | 6 circuits |
| FT-V7A | 7 circuits |
| FT-V8A | 8 circuits |
| FT-V9A | 9 circuits |
| FT-V10A | 10 circuits |
| FT-V11A | 11 circuits |
| FT-V12A | 12 circuits |

With built in flow metres, ball valves, connecting and fixing accessories.
55mm distance.

FLOORHEATING MIXING UNIT



FT-FWR/N

It can circulate the floor heating water in the circuits and keep the supply water temperature on the adjusted value.
Applicable with FT-V2A – FT-V12A.
Sealing included.

BALL VALVE MINI



FT-KH3/4 3/4", Eurocone.

BALL VALVE SET



RP-KH1 1"
Set of 2 pieces of ball stopcocks, 1 blue and 1 red.
Sealing included.

BALL VALVE SET WITH BUILT IN THERMOMETER



RP-KHT-1 1", ball valve with built in thermometer.

MANIFOLD END PIECE SET



RP-MAPS1 Charge-discharge, Air vent.
Sealing included.

MANIFOLD EXTENSION PIECE



RP-MEX-1 1"
Sealing included.

DRINKING AND SANITARY HOT WATER, CENTRAL HEATING AND FLOOR HEATING

END CAP FOR MANIFOLDS 1"



| | |
|-------------------|----|
| RP-BP1 | 1" |
| Sealing included. | |

END CAP FOR MANIFOLDS 3/4"



| | |
|-------------------|------|
| RP-BP3/4 | 3/4" |
| Sealing included. | |

INSULATOR FOR MANIFOLD



| | |
|---------|----------------------------|
| RP-MI-6 | 6 circuits, 55mm distance. |
|---------|----------------------------|

MANIFOLD HOLDER



| | |
|---------|----|
| SF-MBR1 | 1" |
|---------|----|

MANIFOLD BOX - OUT OF THE WALL TYPE

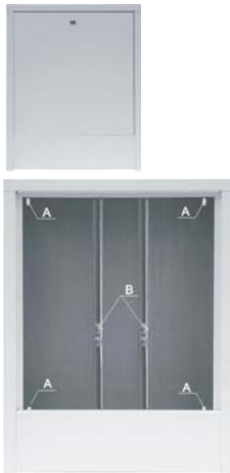

| | |
|---------|------------------------------|
| SF-WEK0 | For 2-3 circuits manifolds. |
| SF-WEK1 | For 4-5 circuits manifolds. |
| SF-WEK2 | For 6-10 circuits manifolds. |

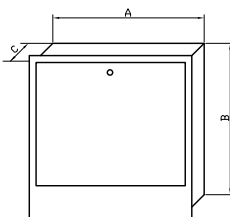

All units are in mm

| A | B | C |
|-----|-----|-----|
| 450 | 585 | 110 |
| 550 | 585 | 110 |
| 800 | 585 | 110 |

MANIFOLD BOX - BUILT IN THE WALL TYPE



| | |
|--------|-------------------------------|
| FT-VK1 | For 2-5 circuits manifolds . |
| FT-VK2 | For 6-9 circuits manifolds . |
| FT-VK3 | For 10-12 circuits manifolds. |

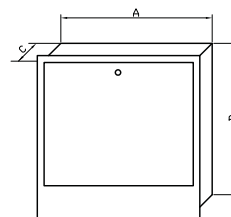

All units are in mm

| A | B | C |
|-----|-----|-----|
| 580 | 680 | 110 |
| 780 | 680 | 110 |
| 930 | 680 | 110 |

THERMOSTATS, REGULATION

THERMOELECTRIC ACTUATOR



| | |
|---|--------------|
| RP-ACT1 | 2 vires type |
| | 4 vires type |
| See page 21. Applicable with RP-CBM It can close and open the floor heating circuits. Applicable with FT-V2A – FT-V12A. | |

ELECTRONIC ROOM THERMOSTAT



| | |
|--------------|----------------------|
| RP-RTH1 | |
| RP-RTH2 | With selection mode. |
| See page 20. | |

ELECTRONIC ROOM THERMOSTAT WITH DISPLAY



| | |
|--------------|--|
| RP-RTD | |
| See page 20. | |

CLOCK THERMOSTAT MILUX



| | |
|--------------|--|
| RP-CTM | |
| See page 20. | |

ELECTRONIC ROOM THERMOSTAT WITH TEMPER-PROOF SETTINGS



| | |
|--------------|--|
| RP-SENS | |
| See page 21. | |

CONNECTING BOX, MASTER



| | |
|--------------|--|
| RP-CBM | |
| See page 21. | |

CONNECTING BOX, SLAVE



| | |
|--------------|--|
| RP-CBS | |
| See page 21. | |

DIGITAL CLOCK TIMER



| | |
|--------------------------------------|--|
| RP-DCT | |
| See page 21. Applicable with RP-CBM. | |

WIRELESS - THERMOSTAT WITH DISPLAY



| | |
|--------------|--|
| RP-RTDRF | |
| See page 21. | |

RF-CLOCK THERMOSTAT MILUX



| | |
|--------------|--|
| RP-CTMRF | |
| See page 22. | |

RF-CONNECTING BOX, MASTER WITH RECEIVER AND TIMER



| | |
|--------------|--|
| RP-CBSRF | |
| See page 22. | |

WIRELESS - CONNECTING BOX, SLAVE



| | |
|--------------|--|
| RP-BMRF | |
| See page 22. | |

WIRELESS - RECIEVER FOR 1 ZONE



RP-RECRF

See page 22.

FLOORHEATING

SYSTEM ROLLE



FT-ROLLE+

10m²

The insulation with thickness of 30 mm, with aluminum sheet and grid
Maximum loading of 3.5 KN/m².

PERIPHERAL DILATATION BAND



FT-RAND16KF

Height 120 + 35 mm, length 25 bm.

FIXING HOOKS



FT-TACKNAD

300 pcs in box

Applicable with FT-TACKGERAT.

FIXING TOOL



FT-TACKGERAT

For fixing the floor heating pipes to the System rolle insulation with FT-TACKNAD fixing hooks.

ESTRICH CONCRETE ADDITIVE



FT-ZUSATZ

5 kg

Additive for floor heating concrete.
It makes the concrete more liquid.
1kg additive for 100kg cement.

PIPE FIXATION

PIPE ANCHOR



SI-HAK60

Simple anchor, length 60 mm, 50 pieces per package.

SI-DUOHAK60

Double anchor, length 60 mm, 50 pieces per package.

BUCKLE



SNAP16

for Ø16 pipe

SNAP20

for Ø20 pipe

SNAP26

for Ø26 pipe

SNAP32

for Ø32 pipe

SNAP40

for Ø40 pipe

SNAP50

for Ø50 pipe

SNAP63

for Ø63 pipe

TOOLS

PRESSING TOOL AKKU



RE-AKPRESS 10-54
 Basic-pack: pressing machine, akku, charger, steel case.
 Max dia.: Ø62mm
 approx. 150 pressing with one charge.

PRESSING TOOL - ELECTRICAL



RE-ELPRESS 10-54
 Basic-pack: pressing machine, steel case.
 Max dia.: Ø108mm.

HAND PRESS TOOL



RE-ECOPRESS
 Max dia.: Ø26mm.

PRESSING JAWS - CONTOUR TH



| | |
|--------------|----|
| RE-PRESSZ 16 | 16 |
| RE-PRESSZ 18 | 18 |
| RE-PRESSZ 20 | 20 |
| RE-PRESSZ 26 | 26 |
| RE-PRESSZ 32 | 32 |
| RE-PRESSZ 40 | 40 |
| RE-PRESSZ 50 | 50 |
| RE-PRESSZ 63 | 63 |

PRESSING TOOL ACCESSORIES



| | |
|--------|--|
| 571510 | Akku, 12V, 2Ah. |
| 565220 | Fast charger 230V, 50-60Hz, 50W. |
| 571535 | 230 V Voltage feeder. |
| 570295 | Sheet-metal case for 6 pressing jawst. |

CALIBRATOR



| | |
|---------|----|
| RP-EK16 | 16 |
| RP-EK18 | 18 |
| RP-EK20 | 20 |
| RP-EK26 | 26 |
| RP-EK32 | 32 |
| RP-EK40 | 40 |
| RP-EK50 | 50 |
| RP-EK63 | 63 |

CUTTING SCISSORS



VAGOOLLOD42 Shear Dyno up 42 mm.

ONE WAY HANDLE FOR CALIBRATOR



RP-EKR

BENDING SPRING – OUTER



| | |
|----------|----|
| RP-BFA16 | 16 |
| RP-BFA18 | 18 |
| RP-BFA20 | 20 |
| RP-BFA26 | 26 |

BENDING SPRING – INNER



| | |
|----------|----|
| RP-BFI16 | 16 |
| RP-BFI18 | 18 |
| RP-BFI20 | 20 |
| RP-BFI26 | 26 |

NOTES

18 horizontal grey bars for taking notes.



INHOUSE SYSTEM

We hope that you, with the aid of this manual, will be able to properly design, store and install all piping systems for in-house supplied by the company Pipelife. Information about them you will find in appropriate product datasheets. In your orders, please, use our catalogue numbers.

Our technical consultancy lies in experience and calculations. In respect to the fact that we do not know and do not have a possibility to influence the conditions of using the products offered by our company, all the data apply as not binding directions. In case of damage our warranty applies only to the value of goods delivered by our company. The guarantees do not apply to qualitative parameters of our products. Right of the data change is reserved.

3. edition

June 2010

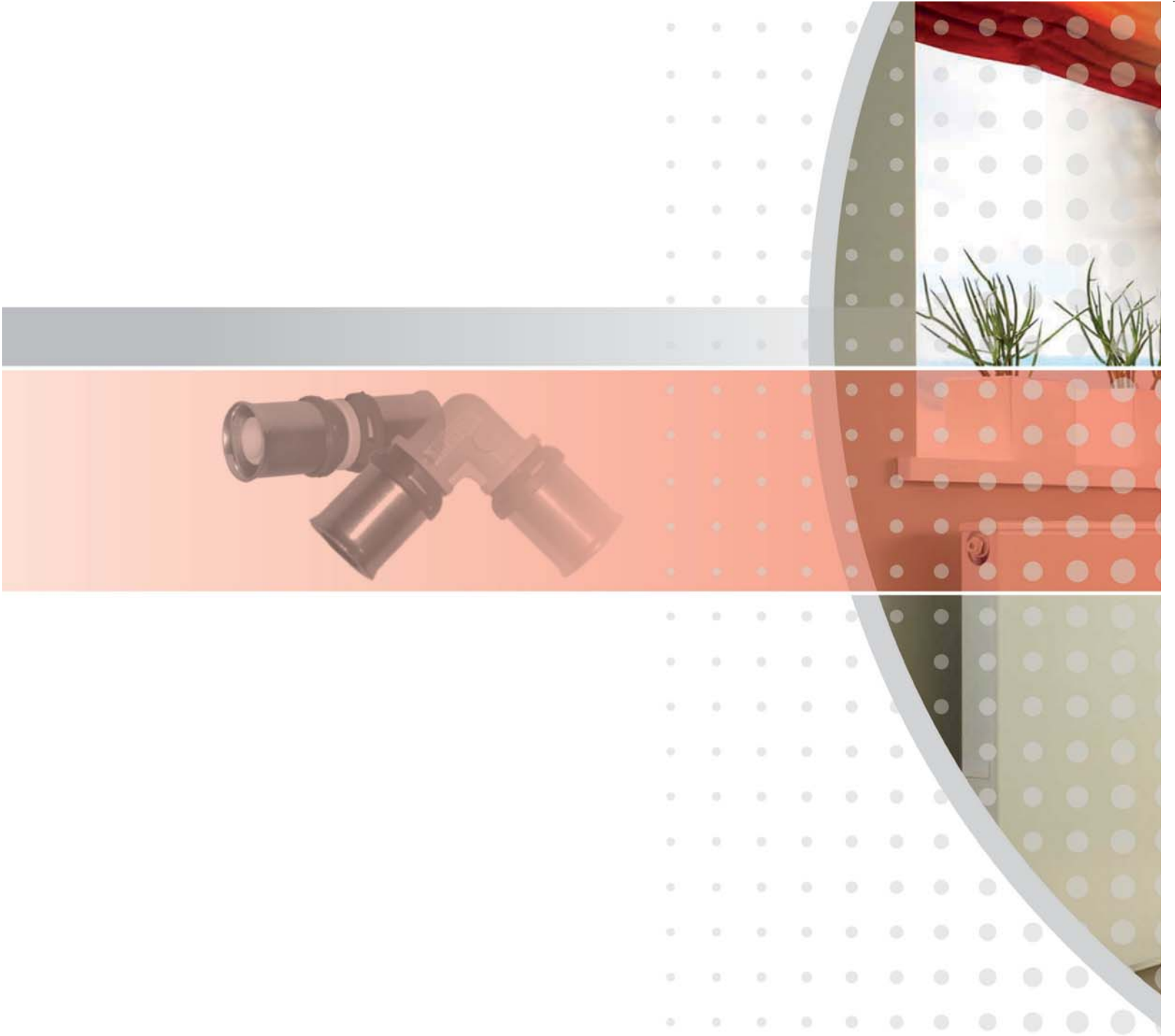

Pipelife International GmbH
Triester Strasse 14
2351 Wr. Neudorf / Austria

tel: +43.2236.43939-0
fax: +43.2236.43939-6